

Crosstrek

2017



Crosstrek. Love where it takes you.

 **SUBARU**
Confidence in Motion

Make plans. Push them further.

The 2017 Crosstrek

Meant for more, the 2017 Crosstrek is a rare combination of capability and efficiency with a high 8.7 inches of ground clearance, standard Subaru Symmetrical All-Wheel Drive, and 33 highway MPG efficiency!¹ Factor in the durability that Subaru is known for—96% of vehicles sold in the last 10 years are still on the road today²—and it's clear: In the Crosstrek, you are going to love where it takes you.



Capable

Its capability starts at the core—the SUBARU BOXER® engine sends power to all four wheels via standard Subaru Symmetrical All-Wheel Drive. Coupled with 8.7 inches of ground clearance, the Crosstrek prompts ambitious plans and unexpected destinations.



Efficient

Get exceptional efficiency without having to sacrifice driving enjoyment and capability. The Crosstrek 2.0i does a lot on very little, achieving up to 33 highway MPG¹ and covering over 500 miles on a single tank.³



Fun

Get out there, but stay connected. The Crosstrek comes standard with SUBARU STARLINK™ Multimedia with Pandora® app integration, available SiriusXM® All Access Radio⁴ and access to apps like iHeart® Radio, Stitcher,[™] Aha[™] and more.⁵ Featuring the choice of either a 6.2- or 7.0-inch touchscreen, every Crosstrek includes Bluetooth® streaming and HD Radio® with iTunes® tagging capability.



Safe

Leaving little to chance, the well-protected 2017 Crosstrek offers available SUBARU STARLINK™ Safety and Security with Automatic Collision Notification to help keep you and your Subaru safe and sound⁶. There are also seven standard airbags⁷ to help protect all aboard, and for added awareness, there are available technologies like EyeSight^{®8} Blind-Spot Detection⁹ and Rear Cross-Traffic Alert⁹ and a standard Rear-Vision Camera.

¹ 2017 EPA fuel economy estimate for Crosstrek 2.0i CVT at 33 highway MPG. Actual mileage may vary. ² Based on IHS Automotive, Polk U.S. VIO Total Registrations MY2006–December 2015. ³ Driving range based on a 15.9-gallon fuel tank capacity and EPA-estimated fuel economy for 2017 Subaru Crosstrek 2.0i models with Lineartronic® CVT at 33 highway MPG. Actual driving range may vary. ⁴ Activation and required monthly subscription sold separately. Includes 4-month trial subscription. Availability varies by trim level. See your retailer. ⁵ Compatible smartphone and applications required. For applications to operate, latest version of each application is required. Data provided by smartphone is displayed on the audio system screen. Some state laws prohibit the operation of handheld electronic devices while operating a vehicle. Smartphone apps should only be launched when vehicle is safely parked. Your wireless carrier's rates may apply. ⁶ Activation and required subscription sold separately. Includes one-year Safety Plus trial subscription. See retailer for details. ⁷ Always wear seatbelts. Children should be properly restrained in the rear seat. ⁸ EyeSight is a driver assist technology, which may not operate optimally under all driving conditions. The driver is always responsible for safe and attentive driving. System effectiveness depends on many factors such as vehicle maintenance, weather and road conditions. See Owner's Manual for complete details on system operation and limitations. Please remember to turn off EyeSight when going through a carwash. ⁹ Blind-Spot Detection, Lane Change Assist and Rear Cross-Traffic Alert are systems designed to assist the driver by monitoring the rear and side areas of the vehicle during a lane change or reversing and are not a substitute for safe and attentive driving.



© 2017 Crosstrek

It's always more fun at the top.

Set your sights high. The Crosstrek is more than ready for the challenge. Carrying cargo is easy in its roomy cargo area and standard integrated roof rails above can accommodate plenty of gear. Rough terrain is a breeze to tackle as well with Subaru Symmetrical All-Wheel Drive and 8.7 inches of ground clearance. Now you can spend less time preparing—and more time doing.

Crosstrek 2.0i Limited in Ice Silver Metallic with optional and accessory equipment.



Crosstrek 2.0i Premium with Black Cloth.

Plug in to play on.



Touchscreen Audio Systems



SUBARU STARLINK™ Smartphone Integration



Text Messaging Capability¹

Interior Technology

Stay entertained and at ease. Standard SUBARU STARLINK™ Multimedia can display incoming texts on screen¹ and grant you access to apps like Pandora,² iHeart® Radio, Stitcher™ and Aha.² Personalize your tunes with standard Bluetooth® streaming, HD Radio® and available SiriusXM® All Access Radio³. Get even more high-tech with available features like Keyless Access with Push-button Start or a 7.0-inch touchscreen navigation system. Plus, available STARLINK™ Safety and Security⁴ can help send first responders when an airbag deploys, help police locate your vehicle if it's stolen and lots more.

¹ STARLINK can read incoming texts out loud when the vehicle is traveling at speeds over 5 miles per hour, and can display incoming texts on screen when the vehicle is traveling at speeds lower than 5 miles per hour. 7.0" system required. ² Compatible smartphone and applications required. For applications to operate, latest version of each application is required. Data provided by smartphone is displayed on the audio system screen. Some state laws prohibit the operation of handheld electronic devices while operating a vehicle. Smartphone apps should only be launched when vehicle is safely parked. Your wireless carrier's rates may apply. ³ Activation and monthly subscription sold separately. Includes four-month trial subscription. See your retailer. ⁴ Activation and required subscription sold separately. Includes one-year Safety Plus trial subscription. See your retailer for details.



All in to go all out.

Roomy Interior

Load gear and friends alike in the capable yet comfortable 2017 Crosstrek. There are plenty of cargo options with 60/40-split flat-folding rear seatbacks and lots of room for passengers with up to 97.5 cubic feet of interior volume. And with the available leather-trimmed steering wheel, shifter and seats, you can enjoy even more comfort and style.

An extra set of eyes **every time you drive.**

Pre-Collision Braking



A driver ahead unexpectedly hits the brakes or cuts you off. EyeSight®¹ warns you, applies the brakes to help avoid it, and at lower speeds can even help you stop your Subaru.

Adaptive Cruise Control

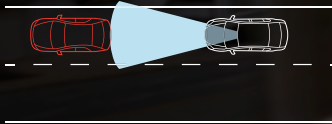

Traffic doesn't always flow, so EyeSight® doesn't only keep a set speed. The system looks ahead and helps the Subaru automatically adjust to keep your distance, even in stop-and-go highway traffic.

Pre-Collision Throttle Management



If you put the car in Drive instead of Reverse and EyeSight® sees an object in your path, it cuts power to help you avoid accelerating into it.

Lane Departure and Sway Warning

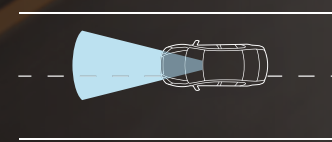

You accidentally drift to the edge of your lane and begin to cross into another. EyeSight® watches for lane markers and chimes to warn you before you leave your lane.



¹ EyeSight is a driver assist technology, which may not operate optimally under all driving conditions. The driver is always responsible for safe and attentive driving. System effectiveness depends on many factors such as vehicle maintenance, weather and road conditions. See Owner's Manual for complete details on system operations and limitations. Please remember to turn off EyeSight when going through a carwash.



Design that leaves **nothing to chance.**

Advanced Safety Features

The 2017 Crosstrek excels at protecting what's inside. It offers standard features like a Rear-Vision Camera and seven airbags,¹ plus Subaru Symmetrical AWD to give you control and confidence, even in unfavorable weather. There are also available features like Blind-Spot Detection with Lane Change Assist and Rear Cross-Traffic Alert² to offer extra awareness when you need it.



Rear Cross-Traffic Alert

Rear Cross-Traffic Alert uses radar sensors to help warn you of traffic approaching from the side as you are backing up, utilizing a flashing visual indicator in your side mirror and an audible warning.²



Blind-Spot Detection

Using radar sensors, Blind-Spot Detection warns you with a visual indicator in your side mirror if it senses a vehicle in your blind spot. Another feature of this system, Lane Change Assist, alerts you with a flashing indicator in your side mirror if it senses a vehicle approaching at a higher speed in a neighboring lane and you signal for a lane change.²

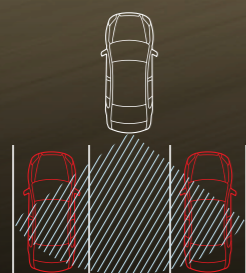

Rear-Vision Camera

Before you can avoid danger, you have to see it coming. The Crosstrek features a standard Rear-Vision Camera that gives you a clearer view of the area behind your vehicle, so you can be in charge of your surroundings.



STARLINK™ Safety and Security

Instant access to help when you need it most 24/7, 365 days a year. That's the reassurance of STARLINK™ Safety and Security, which includes Automatic Collision Notification, Enhanced Roadside Assistance, Stolen Vehicle Recovery, and added convenience with Remote Services. Whether you're in your vehicle, at your computer, or on your mobile device, STARLINK™ Safety and Security helps keep you and your vehicle safe.³

1 Always wear seatbelts. Children should be properly restrained in the rear seat. 2 Blind-Spot Detection, Lane Change Assist and Rear Cross-Traffic Alert are systems designed to assist the driver by monitoring the rear and side areas of the vehicle during a lane change or reversing and are not a substitute for safe and attentive driving. 3 Activation with subscription is required. Includes one-year Safety Plus trial subscription. See your retailer for details.

“Highly competent on paper and on the road. You can’t go wrong with the value that is the capable and comfortable Crosstrek.”

Motor Trend



Subaru has the **best-selling all-wheel drive cars in America** for the past 6 years!

2017 Crosstrek | Trim Levels



2.0i

- 148-hp 2.0-liter 4-cylinder SUBARU BOXER® engine
- Subaru Symmetrical All-Wheel Drive
- 5-speed manual transmission
- Fog lights
- 17-inch aluminum-alloy wheels
- Roof rails, black finish
- Cloth upholstery
- SUBARU STARLINK™ 6.2" Multimedia with Pandora®, iHeart® Radio, Stitcher™ and Aha™ smartphone app integration⁴, high-resolution LCD touchscreen display, 4 speakers, AM/FM/CD player, HD Radio® with iTunes® tagging capability, USB port/iPod® control, Bluetooth® audio streaming and hands-free phone connectivity, and 3.5-mm auxiliary jack

- 6-way manually adjustable driver's seat. 4-way manually adjustable front-passenger's seat.
- Manually adjustable CFC-free air conditioning with air filtration
- Electronic cruise control
- Rear-Vision Camera



2.0i Premium

Includes 2.0i key features and adds:

- Optional Lineartronic® CVT (Continuously Variable Transmission) with manual-mode paddle shifters
- Body-color side mirrors
- Cloth upholstery with orange stitching
- Leather-wrapped 3-spoke steering wheel with orange stitching
- Leather-wrapped shifter handle
- Sliding center console lid with orange stitching

- SUBARU STARLINK™ 6.2" Multimedia with Pandora®, iHeart® Radio, Stitcher™ and Aha™ smartphone app integration⁴, high-resolution LCD touchscreen display, 6 speakers, AM/FM/CD player, HD Radio® with iTunes® tagging capability, USB port/iPod® control, Bluetooth® audio streaming and hands-free phone connectivity, and 3.5-mm auxiliary jack
- All-Weather Package: Heated exterior mirrors, dual-mode heated front seats, windshield wiper de-icer
- Cargo-area cover and tray



2.0i Limited

Includes 2.0i Premium key features and adds:

- Lineartronic® CVT (Continuously Variable Transmission) with manual-mode paddle shifters
- Body-color side mirrors with integrated turn signals
- Leather-trimmed upholstery with orange stitching
- Shifter handle with leather boot, orange stitching and gloss black trim
- Automatic climate control system
- Auto-on/off headlights
- Welcome lighting

- SUBARU STARLINK™ 7.0" Multimedia Plus with Pandora®, iHeart® Radio, Stitcher™ and Aha™ smartphone app integration⁴, high-resolution LCD touchscreen display, voice-activated controls, 6 speakers, AM/FM/CD player, HD Radio® with iTunes® tagging capability, USB port/iPod® control, SiriusXM® All Access Radio⁵ and Travel Link⁶, Bluetooth® audio streaming and hands-free phone and text messaging connectivity, and 3.5-mm auxiliary jack
- STARLINK™ Safety Plus enabled⁶: Automatic Collision Notification, SOS Emergency Assistance, Enhanced Roadside Assistance, Maintenance Notifications, Monthly Vehicle Health Report, Diagnostic Alerts
- Blind-Spot Detection with Lane Change Assist and Rear Cross-Traffic Alert⁷



Subaru is Kelley Blue Book's **2016 Best Overall Brand, Most Trusted Brand, and Best Resale Value?**



According to ALG, the **2016 Subaru Crosstrek maintains its value longer than any other vehicle in the compact car segment.**³

The Big Test: **2015-2016 Subcompact Crossover Winner.**

Motor Trend

¹ Based on IHS, Polk Automotive AWD Total U.S. Registrations December CYE 2010 through December CYE 2015. ² 2016 Kelley Blue Book Brand Image Awards are based on the Brand Watch™ study from Kelley Blue Book Strategic Insights. Award calculated among non-luxury shoppers. Vehicle's projected resale value specific to the 2016 model year. For more information, visit www.kbb.com. Kelley Blue Book is a registered trademark of Kelley Blue Book Co., Inc. ³ ALG is the industry benchmark for residual values and depreciation data, www.alg.com. ⁴ Compatible smartphone and applications required. For applications to operate, latest version of each application is required. Data provided by smartphone is displayed on the audio system screen. Some state laws prohibit the operation of handheld electronic devices while operating a vehicle. Smartphone apps should only be launched when vehicle is safely parked. Your wireless carrier's rates may apply. ⁵ Activation and monthly subscription sold separately. Includes 4-month trial subscription. See your retailer. ⁶ Activation and required subscription sold separately. Includes one-year trial subscription. See your retailer for details. ⁷ Blind-Spot Detection, Lane Change Assist and Rear Cross-Traffic Alert are systems designed to assist the driver by monitoring the rear and side areas of the vehicle during a lane change or reversing and are not a substitute for safe and attentive driving.

2017 Crosstrek | Specifications

Engine and Drivetrain		2.0i
Power Torque	2.0-liter DOHC aluminum-alloy 16-valve horizontally opposed 4-cylinder SUBARU BOXER® engine with Dual Active Valve Control System (DAVCS). 148 hp @ 6,200 rpm 145 lb-ft @ 4,200 rpm	●
Transmission	Fully synchronized 5-speed manual with Incline Start Assist. 2.0i and 2.0i Premium: Standard. 2.0i Limited: N/A.	●
	Lineartronic® CVT (Continuously Variable Transmission) with Adaptive Control, Incline Start Assist and 6-speed manual-mode with paddle shifters. 2.0i: N/A 2.0i Premium: Optional. 2.0i Limited: Standard.	○
CA Emissions		PZEV¹
Maximum towing capacity	1,500 lbs	●
Traction and Stability		
All-Wheel Drive type	Subaru Symmetrical All-Wheel Drive	●
Vehicle Dynamics Control (VDC)	VDC electronic stability control utilizes sensors that constantly monitor wheel speeds, steering angle, brake pressure, vehicle yaw rate and lateral g-forces. If VDC detects a difference between the driver's intended path and the one the vehicle is actually taking, VDC applies braking power and/or reduces engine torque to help correct vehicle path.	●
Traction Control System (TCS)	VDC also incorporates an all-wheel, all-speed traction control system that senses a loss of traction and applies braking force to the slipping wheel or wheels as necessary to maintain vehicle motion.	●
Fuel		
Fuel Economy	city/highway/combined²	Manual: 23/30/26 mpg CVT: 26/33/29 mpg
Fuel Requirement	Unleaded gasoline (87 octane)	●
Fuel Capacity	15.9 gallons	●

2017 Crosstrek | Specifications

Chassis		2.0i
Steering	Electric power-assisted quick ratio rack-and-pinion steering (EPAS). Turning circle: 34.8 feet.	●
Suspension	4-wheel independent raised. Front: MacPherson strut type. Stabilizer bar. Rear: Double wishbone. Stabilizer bar.	●
Brakes	4-wheel disc, ventilated front. 4-channel, 4-sensor ABS with Electronic Brake-force Distribution (EBD).	●
Brake Discs (front/rear)	11.6 inches/10.8 inches	●
Brake Assist	When emergency braking is detected by how quickly the brake pedal is pressed, maximum brake pressure is immediately applied.	●
Brake Override System	If both brake and accelerator pedals are pressed simultaneously, the system reduces the operation of the accelerator pedal to help prevent unintentional vehicle acceleration.	●
Wheels and Tires		
Wheels	2.0i, 2.0i Premium and 2.0i Limited: 17 x 7.0-inch aluminum-alloy. Dark gray with machine finish.	●
Tires	2.0i, 2.0i Premium and 2.0i Limited: 225/55 R17 95H all-season	●
Spare Tire	Temporary use T145/90 D16	●

● Standard ○ Optional — Not equipped

Some images shown are for illustration purposes only. Specifications in this brochure are based on the latest product information available at the time of publication. For the most up-to-date and detailed product information, log on to www.subaru.com. Some equipment shown in photography in this brochure is optional at extra cost. Specific options may be available only in combination with other options. Specific combinations of equipment or features may vary from time to time and by geographic area. Certain accessories and equipment may not be available at the time of publication. Subaru of America, Inc., reserves the right to change or discontinue at any time, without notice, prices, colors, materials, equipment, accessories, specifications, models and packages without incurring any obligation to make the same or similar changes on vehicles previously sold. Colors shown may vary due to reproduction and printing processes.

This brochure was prepared by Subaru of America, Inc. A warranty from Subaru of America, Inc., is available only on cars sold to the first retail purchaser through an authorized Subaru retailer in the continental U.S. or Alaska. Every owner of the car during the warranty period shall be entitled to the benefit of these warranties. Subaru, SUBARU BOXER, EyeSight and Lineartronic are registered trademarks of Fuji Heavy Industries, Ltd. Crosstrek and Added Security are registered trademarks of Subaru of America, Inc. Confidence in Motion and STARLINK are trademarks of Fuji Heavy Industries, Ltd. Aha is a trademark of Harman International Industries, Inc. Bluetooth is a registered trademark of Bluetooth SIG, Inc. HD Radio is a trademark of iBiquity Digital Corporation. HomeLink is a registered trademark of Gentex Corporation. App Store, Apple, iPod and iTunes are registered trademarks of Apple Inc. SiriusXM, Traffic and Travel Link are registered trademarks of SiriusXM Radio Inc. iHeart® Radio is a registered trademark of iHeartMedia, Inc. Pandora is a registered trademark of Pandora Media, Inc. Stitcher is a trademark of Stitcher, Inc. For more information, contact your Subaru retailer or log on to www.subaru.com.

2017 Crosstrek | Equipment

Exterior	2.0i	2.0i Premium	2.0i Limited
Fog lights	●	●	●
Steering Responsive Fog Lights (when equipped with optional EyeSight® Driver Assist Technology)	—	●	●
Black folding side mirrors	●	—	—
Body-color folding side mirrors	—	●	—
Body-color folding side mirrors with integrated turn signals	—	—	●
Body-color door handles	●	●	●
Heated side mirrors and windshield wiper de-icer (All-Weather Package)	—	●	●
Roof rails, black finish	●	●	●
Power tilt/sliding-glass moonroof (95% UVA and 99% UVB light reducing) ³	—	○ ⁴	○ ⁴
Seating and Trim			
6-way manually adjustable driver's seat, 4-way manually adjustable front-passenger's seat.	●	●	●
Heated front seats (All-Weather Package)	—	●	●
60/40-split flat-folding rear seatbacks	●	●	●
Leather-trimmed steering wheel with orange stitching	—	●	●
Leather-wrapped automatic transmission shifter handle with orange stitching	—	○	●
Shifter handle with leather boot, orange stitching and gloss black trim	—	—	●
Cloth upholstery	●	●	—
Leather-trimmed upholstery	—	—	●
Convenience Features			
Keyless Access with Push-button Start and PIN-code vehicle access	—	—	○ ⁴
Welcome lighting (when approaching or departing vehicle)	—	—	●
One-touch lane change feature	●	●	●
Auto-on/off headlights	—	—	●
Driver's auto-up/down power window	●	●	●
Electronic cruise control	●	●	●
3-spoke steering wheel with audio system, Bluetooth®, cruise control or (if equipped) EyeSight® adaptive cruise control buttons	●	●	●
Dual USB ports	—	○ ⁴	●
Automatic transmission manual-mode paddle shifters	—	○	●
Manually adjustable tilt/telescoping steering column	●	●	●
Center console sliding armrest lid with orange stitching	—	●	●
Removable cargo-area tray and cover	—	●	●
Audio System			
SUBARU STARLINK™ 6.2" Multimedia with Pandora®, iHeart® Radio, Stitcher™ and Aha™ smartphone app integration ⁵ , high-resolution LCD touchscreen display, AM/FM/CD player, HD Radio® with iTunes® tagging capability, USB port/iPod® control, Bluetooth® audio streaming and hands-free phone connectivity, and 3.5-mm auxiliary jack	●	●	—
SUBARU STARLINK™ 7.0" Multimedia Plus with Pandora®, iHeart® Radio, Stitcher™ and Aha™ smartphone app integration ⁵ , high-resolution LCD touchscreen display, voice-activated controls, AM/FM/CD player, HD Radio® with iTunes® tagging capability, USB port/iPod® control, SiriusXM® All Access Radio ⁶ and Travel Link® ⁶ , Bluetooth® audio streaming and hands-free phone and text messaging connectivity, and 3.5-mm auxiliary jack	—	○ ⁴	●
4 speakers	●	—	—
6 speakers	—	●	●
Climate Control			
Manually adjustable CFC-free air conditioning system with air filtration and rotary controls for temperature, 4-speed fan and airflow direction	●	●	—
Automatic climate control system with CFC-free air conditioning, air filtration and rotary controls for temperature, fan speed and airflow direction	—	—	●
Instrumentation			
Analog speedometer, tachometer, "eco" fuel economy and fuel level gauges with LCD display	●	●	●
Multifunction display with driving range, average fuel economy, journey time, average vehicle speed, clock and ambient temperature gauge with road surface freeze warning indicator (color on 2.0i Premium and Limited trims equipped with EyeSight®)	●	●	●

2017 Crosstrek | Equipment

Security	2.0i	2.0i Premium	2.0i Limited
Keyless entry system with answer-back electronic chirp	●	●	●
Antitheft security system with engine immobilizer	●	●	●
Safety			
ACTIVE			
Subaru Symmetrical All-Wheel Drive (AWD)	●	●	●
EyeSight® Driver Assist Technology ^{4,7}	—	○	○
Blind-Spot Detection with Lane Change Assist and Rear Cross-Traffic Alert ⁸	—	○ ⁴	●
Vehicle Dynamics Control (VDC) with Traction Control System (TCS)	●	●	●
4-wheel antilock braking system (ABS) with Electronic Brake-force Distribution (EBD)	●	●	●
Brake Assist	●	●	●
Brake Override System	●	●	●
Rear-Vision Camera	●	●	●
Tire Pressure Monitoring System (TPMS)	●	●	●
Daytime Running Lights (DRL)	●	●	●
PASSIVE			
STARLINK™ Safety Plus enabled ⁹ : Automatic Collision Notification, SOS Emergency Assistance, Enhanced Roadside Assistance, Maintenance Notifications, Monthly Vehicle Health Report, Diagnostic Alerts	—	○ ⁴	●
Dual-stage deployment driver and front-passenger front airbags (SRS) ¹⁰	●	●	●
Subaru advanced frontal airbag system (SRS) ¹⁰	●	●	●
Side-curtain airbags protecting front and rear outboard occupants (SRS) ¹⁰	●	●	●
Seat-mounted front side-impact airbags (SRS) ¹⁰	●	●	●
Driver's side knee airbag (SRS) ¹⁰	●	●	●
Whiplash protection front seats with height-adjustable head restraints	●	●	●
Three individual rear-seat head restraints	●	●	●
Height-adjustable 3-point front seatbelts with pretensioners and force limiters. 3-point seatbelts at all rear seating positions.	●	●	●
LATCH system: Lower Anchors and Tethers for CHildren	●	●	●
Optional Equipment			
STARLINK™ Safety Plus & Security Plus ¹¹	—	○	○
Lineartronic® CVT (Continuously Variable Transmission)	—	○	●
Lineartronic® CVT • Power Moonroof	—	○	—
Lineartronic® CVT • EyeSight® Driver Assist Technology ⁷ • SUBARU STARLINK™ 7.0" Multimedia Plus • Blind-Spot Detection with Lane Change Assist and Rear Cross-Traffic Alert ⁸ • STARLINK™ Safety Plus enabled ⁹	—	○	—
Power Moonroof • Keyless Access with Push-button Start and PIN-code vehicle access • SUBARU STARLINK™ 7.0" Multimedia Navigation	—	—	○
Power Moonroof • Keyless Access with Push-button Start and PIN-code vehicle access • SUBARU STARLINK™ 7.0" Multimedia Navigation • EyeSight® Driver Assist Technology ⁷	—	—	○

EQUIPMENT CONTENTS

SUBARU STARLINK™ 7.0" Multimedia Plus with Pandora®, iHeart® Radio, Stitcher™ and Aha™ smartphone app integration⁵, high-resolution LCD touchscreen display, voice-activated controls, AM/FM/CD player, HD Radio® with iTunes® tagging capability, USB port/iPod® control, SiriusXM® All Access Radio⁶ and Travel Link®⁶, Bluetooth® audio streaming and hands-free phone and text messaging connectivity, and 3.5-mm auxiliary jack

SUBARU STARLINK™ 7.0" Multimedia Navigation: Voice-activated 7-inch multi-touch gesture high-resolution GPS navigation system with SiriusXM® All Access Radio⁶, Traffic®¹² and Travel Link®¹², USB port/iPod® control, Bluetooth® audio streaming, voice-activated controls, hands-free phone and text messaging connectivity, 3.5-mm auxiliary jack and Pandora®, iHeart® Radio, Stitcher™ and Aha™ smartphone app integration⁵. Voice activation for Navigation, Phone and Audio System

EyeSight® Driver Assist Technology⁷: Pre-Collision Braking System, Pre-Collision Throttle Management, Lane Departure and Sway Warning, Adaptive Cruise Control

STARLINK™ Safety Plus & Security Plus¹¹: Includes STARLINK™ Safety Plus connected services and adds Stolen Vehicle Recovery, Remote Lock/Unlock, Remote Horn & Lights, Remote Vehicle Locator and Vehicle Security Alarm Notification

● Standard ○ Optional — Not equipped



Trailer Hitch. Rated at 200 lbs tongue weight with 1,500 lbs of towing capacity. Engineered to the same rigorous standards as the rest of the Crosstrek.

Hitch ball not included. Trailer brakes may be required.



Cargo Net. Neatly holds cargo and prevents it from sliding while the vehicle is in motion.



Crossbar Set - Aero. Increase your vehicle's cargo-carrying capabilities by adding a crossbar set. These aero-style crossbars may be used in conjunction with Genuine Subaru roof attachments and carriers.



Body Side Moldings. Attractive color-matched moldings coordinate with the styling of the vehicle while helping to protect the doors from unsightly dings.



Splash Guards. Help protect vehicle paint finish from stones and road grime. Set of four.



Roof Spoiler. Adds a sporty finishing touch to the Crosstrek.



Rear Bumper Cover. Helps protect the upper surface of the painted bumper from scratches and dings.



All-weather Floor Mats. Custom-fitted heavy gauge floor mats help protect the vehicle carpet from sand, dirt and moisture.

Not intended for use on top of Carpeted Floor Mats.



Rear Seatback Protector. Provides additional protection to the rear seatbacks when lowering the seats to transport larger cargo.



Side Window Deflectors. Designed to let the fresh air in while helping to keep the rain out of the vehicle.

May not be legal in all states. Please check the laws of your state.



Auto-dimming Mirror with HomeLink® This upgraded auto-dimming mirror detects glare and darkens automatically to protect your vision while featuring an 8-point digital compass. Three backlit HomeLink® buttons can be programmed to operate most garage doors, security gates, home lighting and more. Can also provide you with the last status of your garage door (open or closed) if programmed to a compatible opener featuring two-way communication.



Remote Engine Starter. Allows vehicle to start from the convenience of home or the office (up to 400 feet away depending on obstructions) so that the vehicle interior temperature is more comfortable upon entry. Remote confirms when vehicle engine has been started.

A/T only. A different Remote Engine Starter system is available for vehicles equipped with Push-button Start.

Protecting Your Investment

Once you're part of our family, we'll be there for you. Every Subaru comes with 24-hour roadside assistance for 3 years or 36,000 miles. If you have trouble on the road, a tow to the nearest Subaru retailer and other services are just a phone call away. And to protect you over the long haul, we offer Added Security® ...ask for it by name—extended service agreements and maintenance plans that will help protect your car for up to 7 years or 100,000 miles. They're the only mechanical and maintenance plans backed by Subaru, and because we've been backing them for more than 30 years, they're agreements you can trust. Your retailer has full coverage details.

Subaru Badge of Ownership

True commitment shows through. For Subaru owners, it shows in kayak scuffs and snowboard scratches. It can take the form of dog hair that just won't come out, fresh coats of dust, or extra coats of wax. For many, the Subaru Badge of Ownership lets them show their commitment to the life they live and the confidence that has inspired them to fully embrace it. Owners can order badges online for free, stick them on, and let everyone know how they experience the world. Which one will you get?



Durability

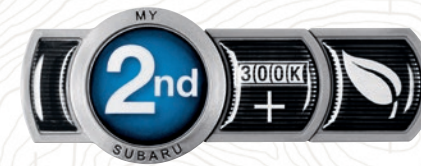

It's not disposable. It's family.

Life moves fast. Don't slow it down with a car you can't trust. At Subaru, we build each of our vehicles with the highest standards of manufacturing, and with designs that are inherently tough and resilient. It's why our vehicles excel in the extreme rigors of rally racing. And why 96% of all vehicles sold in the last 10 years are still on the road today.¹³ It's also why Subaru owners are so likely to stay Subaru owners for years and years. What's more, keeping cars on the road means they stay out of landfills longer. And if we can make the world a cleaner and greener place while making cars that inspire and motivate their drivers, we've done our job.

Warranties

New Car Limited Warranty	3 years or 36,000 miles, whichever comes first.
Powertrain Limited Warranty	5 years or 60,000 miles, whichever comes first.
Wear Item Limited Warranty	3 years or 36,000 miles, whichever comes first. Repairs to the following items will also be covered under Wear Item Limited Warranty: <ul style="list-style-type: none"> • Brake Pads • Wiper Blades • Clutch Linings • Transmitter Batteries
Rust Perforation Limited Warranty	5 years, unlimited mileage.
24-hour Roadside Assistance	3 years or 36,000 miles, whichever comes first.

1 2017 Subaru Crosstrek 2.0i models achieving a Partial Zero Emission Vehicle (PZEV) rating by the California Air Resources Board are available in all 50 states. Only those registered in California, Connecticut, Maine, Maryland, Massachusetts, New Jersey, New York, Rhode Island and Vermont will be eligible for the 15 years/150,000 miles emission warranty. Delaware, Oregon, Pennsylvania and Washington vehicles are not covered under PZEV emissions control warranty. See your warranty maintenance booklet for additional information. 2 2017 EPA fuel economy estimates. Actual mileage may vary. 3 The glass information listed represents calculated reference values and may not represent actual values determined by testing. 4 Available only with other features. See Optional Equipment listing. 5 Compatible smartphone and applications required. For applications to operate, latest version of each application is required. Data provided by smartphone is displayed on the audio system screen. Some state laws prohibit the operation of handheld electronic devices while operating a vehicle. Smartphone apps should only be launched when vehicle is safely parked. Your wireless carrier's rates may apply. 6 Activation and required monthly subscription sold separately. Includes 4-month trial subscription. See your retailer. 7 EyeSight is a driver assist technology, which may not operate optimally under all driving conditions. The driver is always responsible for safe and attentive driving. System effectiveness depends on many factors such as vehicle maintenance, weather and road conditions. Pre-Collision Braking System is designed to provide automatic braking that either prevents a collision or reduces the severity of a frontal impacts. Pre-Collision Throttle Management is designed to reduce acceleration and minimize the severity of certain frontal impacts. Adaptive Cruise Control and Brake Light Recognition are designed to assist the driver and are not substitutes for safe and attentive driving. The Lane Departure and Sway Warning operates only when the lane markings are visible and its effectiveness depends on many factors. See Owner's Manual for complete details on system operation and limitations. Please remember to turn off EyeSight when going through a carwash. 8 Blind-Spot Detection, Lane Change Assist and Rear Cross-Traffic Alert are systems designed to assist the driver by monitoring the rear and side areas of the vehicle during a lane change or reversing and are not a substitute for safe and attentive driving. 9 Activation and required subscription sold separately. Includes one-year trial subscription. See retailer for details. 10 The Supplemental Restraint System (SRS) (airbags) affords the driver and the front and rear outboard passengers additional protection in moderate to severe frontal and side-impact collisions. This system provides supplemental protection only, and seatbelts must be worn in order to avoid injuries to out-of-position occupants upon airbag deployment and to provide the best combined protection in a serious accident. Children should always be properly restrained in the rear seat. 11 Activation with subscription is required. See your retailer for details. 12 Activation and required subscription sold separately. Includes 3-year trial subscription. See your retailer for details. 13 Based on IHS Automotive, Polk U.S. VIO Total Registrations MY2006–December 2015.



Cargo Net. Neatly holds cargo and prevents it from sliding while the vehicle is in motion.



Crossbar Set - Aero. Increase your vehicle's cargo-carrying capabilities by adding a crossbar set. These aero-style crossbars may be used in conjunction with Genuine Subaru roof attachments and carriers.



Splash Guards. Help protect vehicle paint finish from stones and road grime. Set of four.



Roof Spoiler. Adds a sporty finishing touch to the Crosstrek.



STI Alloy Wheel



STI Leather Shift Knob



STI Rear Spoiler



All-weather Floor Mats. Custom-fitted heavy gauge floor mats help protect the vehicle carpet from sand, dirt and moisture.

Not intended for use on top of Carpeted Floor Mats.



Rear Seatback Protector. Provides additional protection to the rear seatbacks when lowering the seats to transport larger cargo.



Auto-dimming Mirror with HomeLink® This upgraded auto-dimming mirror detects glare and darkens automatically to protect your vision while featuring an 8-point digital compass. Three backlit HomeLink® buttons can be programmed to operate most garage doors, security gates, home lighting and more. Can also provide you with the last status of your garage door (open or closed) if programmed to a compatible opener featuring two-way communication.



Remote Engine Starter. Allows vehicle to start from the convenience of home or the office (up to 400 feet away depending on obstructions) so that the vehicle interior temperature is more comfortable upon entry. Remote confirms when vehicle engine has been started.

A/T only. A different Remote Engine Starter system is available for vehicles equipped with Push-button Start.

Sport Package

Give your 2017 Crosstrek an exclusive, custom look. The available Crosstrek Sport Package includes four STI 15-spoke black-finish alloy wheels with STI-branded center caps for the perfect blend of attitude and style.

A black, flush-mounted STI rear spoiler with the STI logo on both sides adds a sporty touch, while an STI black leather shift knob¹ delivers a sophisticated performance look inside.

1 Available on CVT models only.



Let nothing hold you back.

When your passion is bigger than your cargo area, Genuine Subaru active lifestyle accessory attachments manufactured by Thule® are a smart way to securely transport larger gear like bikes, skis, snowboards, kayaks, paddleboards and more. Each carrier safely attaches to your roof rack and can be removed if needed.



Thule® Ski / Snowboard Carrier



Thule® Paddleboard Carrier



Thule® Cargo Carrier

2017 Crosstrek | Dimensions

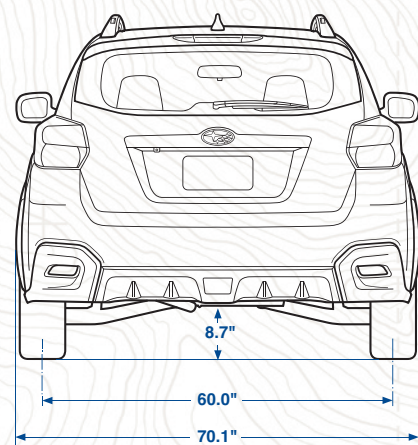
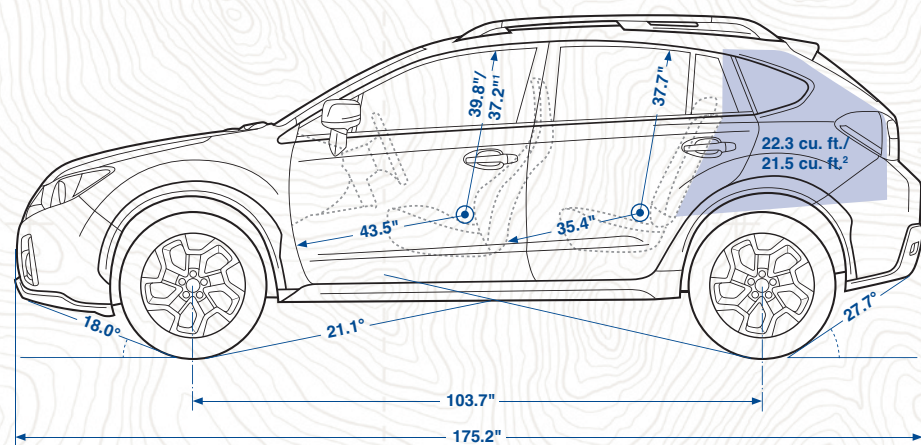

Length/Width/Height	175.2 inches/70.1 inches (78.9/79.5 ² inches, including mirrors)/63.6 inches (with roof rails)
Wheelbase	103.7 inches
Track (front/rear)	60.0 inches/60.0 inches
Base curb weight (manual/automatic)	2.0i: 3,109 lbs/N/A 2.0i Premium: 3,109 lbs/3,186 lbs 2.0i Limited: N/A/3,208 lbs
Ground clearance	8.7 inches (at base curb weight)

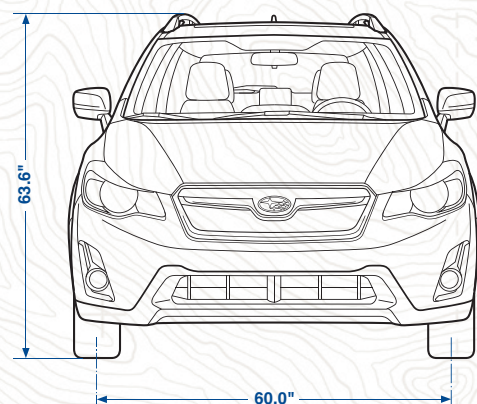
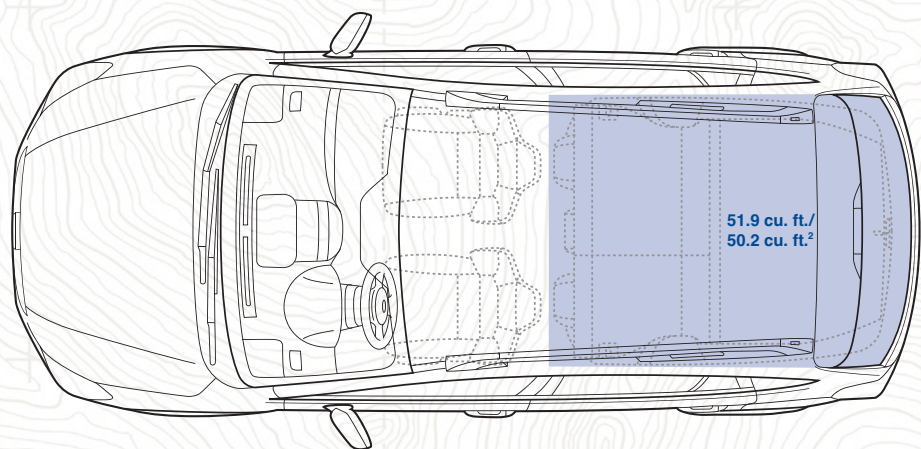

Headroom (front/rear)	39.8 inches/37.7 inches (with moonroof: 37.2 inches/37.7 inches)
Legroom (front/rear)	43.5 inches/35.4 inches
Shoulder room (front/rear)	55.6 inches/54.2 inches
Hip room (front/rear)	52.2 inches/53.1 inches
Passenger volume	97.5 cubic feet (with moonroof: 94.0 cubic feet)
Cargo volume	2.0i: 22.3 cubic feet
Maximum cargo volume	2.0i: 51.9 cubic feet (with rear seatback lowered)

¹ With available moonroof. Moonroof availability varies by trim level.
² With integrated turn signals.

2017 Crosstrek | Colors

Paint



Crystal White Pearl

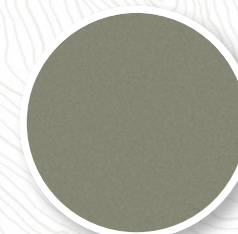

Desert Khaki



Ice Silver Metallic

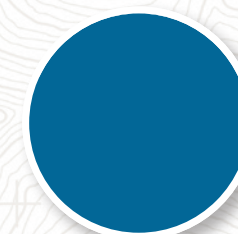

Hyper Blue

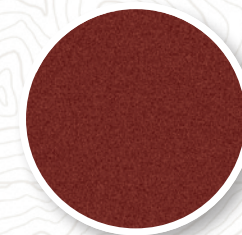

Venetian Red Pearl

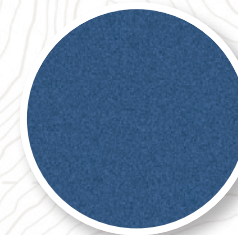

Quartz Blue Pearl

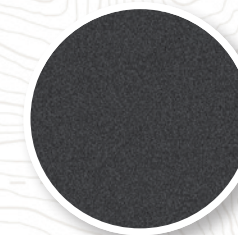

Dark Gray Metallic

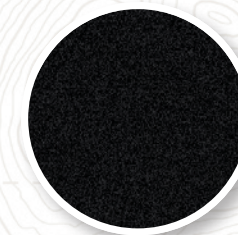

Crystal Black Silica

Upholstery

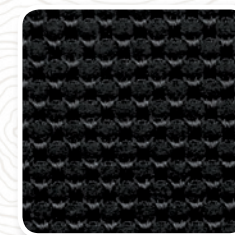

Black Cloth
(BC)

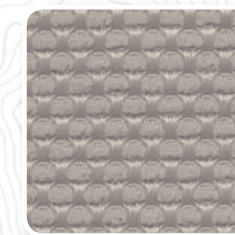

Ivory Cloth
(IC)



Black Leather
(BL)



Ivory Leather
(IL)

Color Combinations

	2.0i	2.0i Premium	2.0i Limited
Crystal White Pearl	BC	BC or IC	BL or IL
Desert Khaki	BC	BC	BL
Ice Silver Metallic	BC	BC	BL
Hyper Blue	BC	BC	BL
Venetian Red Pearl	BC	IC	IL
Quartz Blue Pearl	BC	IC	IL
Dark Gray Metallic	BC	BC	BL
Crystal Black Silica	BC	BC or IC	BL or IL

Take a Guided Tour

It's the ultimate way to get to know the Crosstrek on your terms. Get up close and personal with color configurators, videos, 360-views, interactive content and more.



Online:

tour.subaru.com/Crosstrek2017



App Store:

tour.subaru.com/Crosstrekapp



These brochures were printed with vegetable-based inks and produced using a "Green Printing Process." The Forest Stewardship Council® (FSC®) is an international organization that brings people together to find solutions which promote responsible stewardship of the world's forests and environments.

By producing these brochures in a green way rather than by traditional methods, we saved 86 trees preserved for the future; 40,489 gallons of wastewater flow saved; 2,710 lbs solid waste not generated; 7,465 lbs net greenhouse gases prevented; 39,000,000 BTUs energy not consumed. Calculations provided by Environmental Paper Network. FSC® is not responsible for any calculations on saving resources by choosing this paper.

This brochure is printed in the U.S.A. on 10% recycled paper. ©2016 Subaru of America, Inc. 17CTK.SRB.525 (S-18273, 175K, 9/16, CG)

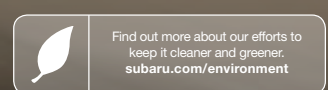

Love. It's what makes a Subaru, a Subaru.

