



ATS

2013
ALL-NEW CADILLAC ATS



ATS

ARCHITECTURE

PERFORMANCE

EXTERIOR

LIGHTING

INTERIOR

CUE

SAFETY TECHNOLOGY

COLLECTIONS

COLOR

WHEELS & SPECS

BUILT FROM THE GROUND UP

TO BE THE WORLD'S BEST SPORT SEDAN.



ATS PREMIUM COLLECTION / Crystal Red Tintcoat

Quick. Nimble. Responsive. The all-new Cadillac ATS. Derivative of nothing, it was built from a clean slate with the world's most respected sport sedans in its crosshairs, then tested and perfected under the extraordinary demands of Germany's famed Nürburgring. Riding on an all-new architecture, the ATS is purposefully designed to deliver remarkable handling and control. Endowed with powerful direct-injection engines, a ZF premium steering system, available race-inspired Brembo® front brakes and the latest generation of revolutionary Magnetic Ride Control, the ATS is a driver-focused luxury sport sedan that delivers thrilling performance. But we didn't stop there. The refined, handcrafted, cut-and-sewn interior is finished with premium materials and the latest technology like CUE¹—Cadillac User Experience. It's a brilliantly executed fusion of luxury and sport.

Quick. Nimble. Responsive. The all-new Cadillac ATS. Derivative of nothing, it was built from a clean slate with the world's most respected sport sedans in its crosshairs, then tested and perfected under the extraordinary demands of Germany's famed Nürburgring. Riding on an all-new architecture, the ATS is purposefully designed to deliver remarkable handling and control. Endowed with powerful direct-injection engines, a ZF premium steering system, available race-inspired Brembo® front brakes and the latest generation of revolutionary Magnetic Ride Control, the ATS is a driver-focused luxury sport sedan that delivers thrilling performance. But we didn't stop there. The refined, handcrafted, cut-and-sewn interior is finished with premium materials and the latest technology like CUE¹—Cadillac User Experience. It's a brilliantly executed fusion of luxury and sport.

GET THE LATEST FROM CADILLAC

Get news, events, info and updates—
all in a monthly e-mail.

SIGN UP >>

1. Full functionality requires compatible Bluetooth® and smartphone. Some devices require USB connectivity.

*MASTER ITS CURVES,
AND YOU'VE GOT YOUR PRIORITIES STRAIGHT.*

The mo
to grea
the all-
dema
German
70-plus
compon
deserve
By end
aspect
to push
perfect
the stat
world-c
handlin

Most difficult roads are the ones that lead to greatness. While engineering and perfecting the new ATS, we went to the toughest, most challenging automotive track on the planet: Porsche's legendary Nürburgring. Over 200 turns in 12.9 miles, it stresses every component to its limit, sometimes beyond, and has earned the nickname "Green Hell." During this grueling punishment, every detail of the agile ATS was tuned and retuned to push the performance envelope as close to the limit as possible. We set out to challenge the status quo. What we accomplished is a new class luxury sport sedan with tenacious handling and performance.



It stands to reason that building a world-class luxury sport sedan requires world-class components. That is why we worked with highly acclaimed companies like ZF to construct and fine-tune the premium speed-sensitive electric steering system. We teamed with world-renowned Brembo[®] to develop the available 4-piston fixed-caliper front brake system, which provides remarkable and repeatable stopping power. And we worked hand in hand with Tremec[®] to design an available precision 6-speed manual transmission tailored specifically for the ATS. Then we went a step further and made class-exclusive Magnetic Ride Control available, which adjusts the suspension almost instantaneously to changing surfaces, camber and conditions, up to 1,000 times a second. It's credentials like these, along with the available performance seats and limited-slip rear differential, that define the ATS as not only a luxury car, but also a bona fide driver's car.

ZF PREMIUM STEERING SYSTEM

A highly acclaimed manufacturer of steering systems, ZF created the electric assist speed-sensitive steering rack for the ATS. It not only helps save fuel¹ by eliminating the traditional power-robbing hydraulic pump, but also delivers precise feel with the perfect amount of effort.

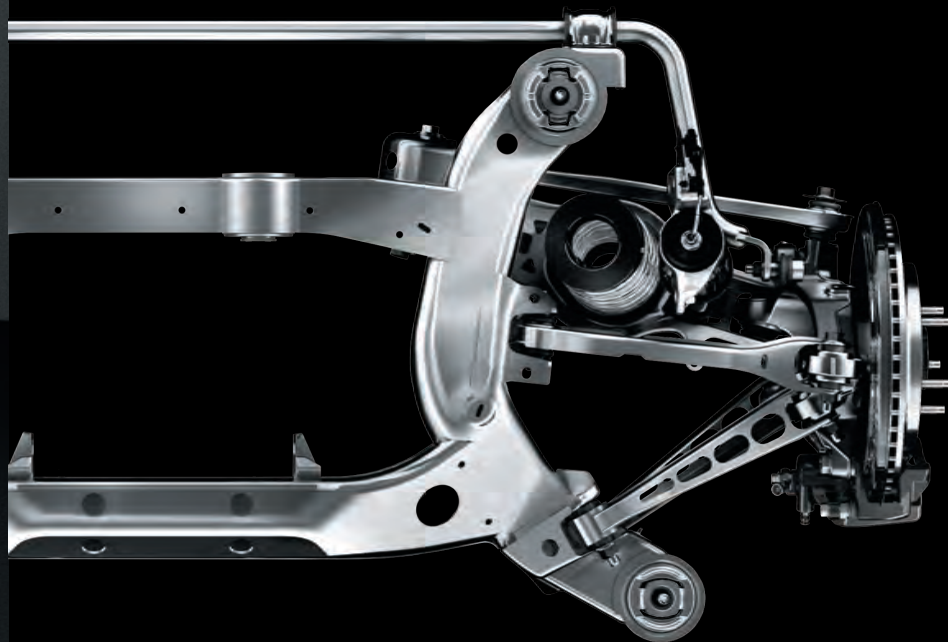

PURPOSE-BUILT SUSPENSION GEOMETRY

Using a double-pivot MacPherson strut in the front and a five-link rear design (shown above), the independent suspension in the ATS was purposely engineered for responsive, nimble handling with excellent refinement.

1. EPA-estimated 22 city/33 highway MPG for 2.5L engine, 21 highway/31 city MPG for 2.0L engine RWD with automatic transmission and 19 city/28 highway MPG for 3.6L engine RWD.

LIMITED-SLIP REAR DIFFERENTIAL

Maximum grip means maximum performance. The ATS features an available mechanical limited-slip rear differential that ensures the highest amount of engine torque is transferred to the wheel with the most traction.



*WORLD-CLASS PERFORMANCE BEGINS WITH
WORLD-CLASS COMPONENTS.*

MAGNETIC RIDE CONTROL

Now in its third generation, available revolutionary Magnetic Ride Control reads the road up to 1,000 times per second and seamlessly adjusts damping for exceptional ride, handling and control.



BREMBO BRAKES

Power is nothing without control. So, we combined forces with the world-renowned brake experts at Brembo to engineer the available fixed-caliper 4-piston front brakes that deliver remarkable stopping power and consistent pedal feel.

STRONG FOUNDATIONS

ARE MADE FROM MORE THAN JUST

IRON AND GRANITE.



0°

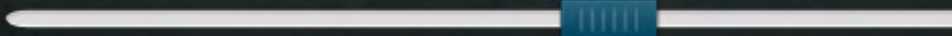

MOVE SLIDER TO VIEW ANGLES

*STRONG FOUNDATIONS
ARE MADE FROM MORE THAN JUST
IRON AND GRANITE.*



0°

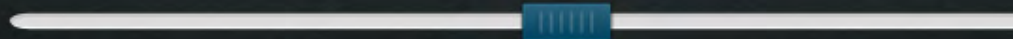

MOVE SLIDER TO VIEW ANGLES



Similar to the world's top athletes, the ATS is built on an incredibly strong yet lean architecture for quickness and agility. Lightest in its class, every component of the all-new chassis was evaluated down to the gram to reduce weight without sacrificing strength, durability or safety. The result is the perfect combination of ultra-high-strength steel, aluminum, magnesium and other advanced materials, which creates a luxury sport sedan that's extremely robust while still athletic and composed. A near-perfect front-to-rear 50/50 weight balance, low center of gravity and distinct suspension geometry blend flawlessly with performance-tuned Rear-Wheel Drive or available all-weather-capable All-Wheel Drive. Engaging and responsive, the ATS luxury sport sedan delivers an exhilarating driving experience that is nothing short of electrifying.

70°



Similar to the world's top athletes, the ATS is built on an incredibly strong yet lean architecture for quickness and agility. Lightest in its class, every component of the all-new chassis was evaluated down to the gram to reduce weight without sacrificing strength, durability or safety. The result is the perfect combination of ultra-high-strength steel, aluminum, magnesium and other advanced materials, which creates a luxury sport sedan that's extremely robust while still athletic and composed. A near-perfect front-to-rear 50/50 weight balance, low center of gravity and distinct suspension geometry blend flawlessly with performance-tuned Rear-Wheel Drive or available all-weather-capable All-Wheel Drive. Engaging and responsive, the ATS luxury sport sedan delivers an exhilarating driving experience that is nothing short of electrifying.

70°

ATS

ARCHITECTURE

PERFORMANCE

EXTERIOR

LIGHTING

INTERIOR

CUE

SAFETY TECHNOLOGY

COLLECTIONS

COLOR

WHEELS & SPECS

*RESPONSE AND RESPONSIBILITY
HAVE NEVER BEEN CLOSER.*



2.0L TURBO ENGINE

Delivering a powerful 272 HP punch with a best-in-class 136 HP per liter, the available 2.0L Turbo with twin scroll technology is deftly smooth and incredibly responsive, while remaining remarkably fuel-efficient.¹ What's more, the engine produces 260 lb.-ft. of torque available over a wide RPM range.

BOSE® ACTIVE NOISE CANCELLATION

Cadillac went to great lengths to make the cabin of the all-new ATS as quiet as possible. A prime example of this is Bose® Active Noise Cancellation. It actively monitors engine noise and sends out opposing nonaudible frequencies through the speakers to quiet these sounds.



ATS PREMIUM COLLECTION / Radiant Silver Metallic

High tech means high output. At a potent 272 HP, the new 2.0L Turbo engine available in the ATS handily trumps the output of comparable competitor engines. Extremely responsive yet refined and efficient,¹ it even uses direct injection and VVT to help improve fuel economy. Further integrating high performance into its advanced formula, the ATS also offers a muscular 3.6L direct-injection V6 producing 321 HP, or a very efficient¹ 2.5L direct-injection 4-cylinder engine with 202 HP.

1. EPA-estimated 21 highway/31 city MPG for 2.0L engine RWD with automatic transmission. AWD estimates not yet available.





ATS EXTERIOR



ATS PREMIUM COLLECTION / Thunder Gray ChromaFlair®

Expressive and athletic, the ATS seamlessly fuses form with function. Taut, chiseled sheet metal allows the ATS to slice through the air with little resistance, affording a quiet cabin and remarkable fuel efficiency.¹ It has advanced aerodynamic innovations like active aero grille shutters that close automatically when additional engine cooling is not needed, and inconspicuous underbody aero shields that direct

air smoothly around and under the vehicle for maximum efficiency.¹ Sculpted side mirrors are precisely formed and positioned to help reduce wind noise. And, in the rear, the LED center brake lamp doubles as a spoiler to ingeniously channel air off the decklid for added downforce and a pleasant feel at high speed. When it came to the details, we just couldn't leave well-enough alone.

*IT'S AERODYNAMIC,
EVEN IN PLACES YOU CAN'T SEE.*

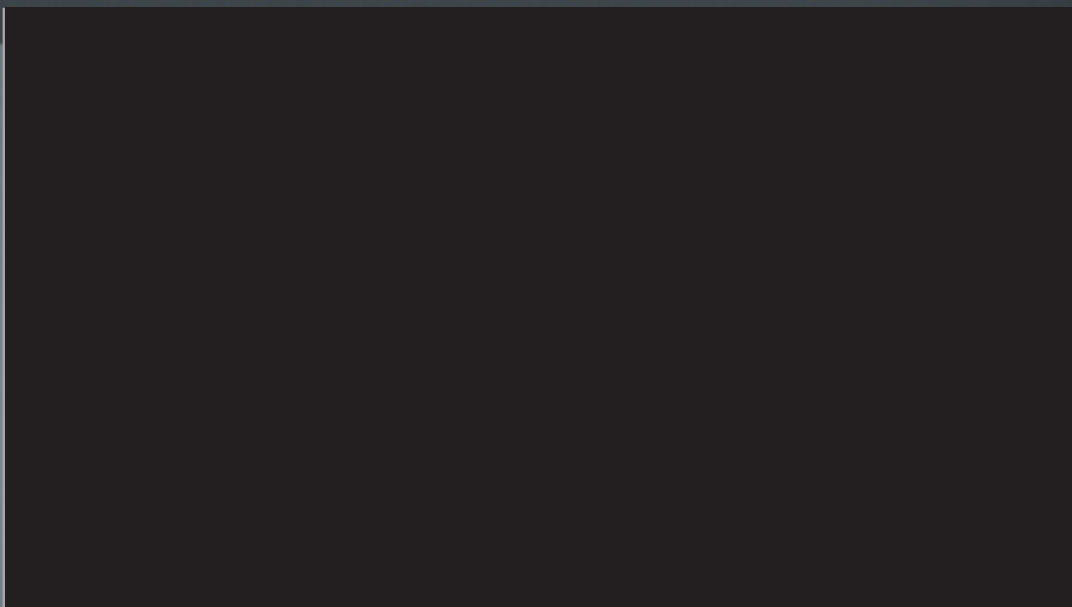

AERODYNAMIC DESIGN

To help the ATS slice through the air, Cadillac designed its exterior to be extremely aerodynamic, even the parts you can't see. Underbody aero shields, available active grille shutters, and more, are just part of its complete aerodynamic package.

1. EPA-estimated 22 city/33 highway MPG for 2.5L engine, 21 highway/31 city MPG for 2.0L engine RWD with automatic transmission and 19 city/28 highway MPG for 3.6L engine RWD.

EXTERIOR DESIGN

Athletic and expressive, the ATS exquisitely fuses form with function. Besides giving it a bold, distinctive appearance, its taut lines allow the ATS to slice through the air, while brilliant details like available illuminating door handles add sophistication.

CLICK THE HOTSPOTS TO VIEW DETAILS





ATS

ARCHITECTURE

PERFORMANCE

EXTERIOR

LIGHTING

INTERIOR

CUE

SAFETY TECHNOLOGY

COLLECTIONS

COLOR

WHEELS & SPECS



*SOME IDEAS ARE JUST BRIGHTER
THAN OTHERS.*



***ILLUMINATING DOOR
HANDLES***



***DIRECTIONAL HID HEADLAMPS
WITH SIGNATURE LED LIGHTING***

Whether it's a history
brought to life through
brings an unmistakable
white LED front signature
to other drivers with
from the top of the bonnet
valance. During the



ATS PERFORMANCE COLLECTION / Radiant Silver Metallic

...ric theater or modern gallery, fine art is
...gh dramatic lighting. Brilliant illumination
...ble presence to the ATS. Available bright-
...nature lamps make the ATS more visible
...a distinctive razor-like design that flows
...beautifully sculpted fender down to the lower
...day, these bright-white LEDs also act as

Daytime Running Lamps. The available HID headlamps feature Adaptive Forward Lighting, which reacts to the car's speed and steering, swiveling the headlamps to cast light precisely into your path of travel. Exterior door handles are available with subtle LED accent strips, adding a welcoming touch on a dark night. And, for those following, signature LED taillamps and a brilliant center brake lamp spark instant Cadillac recognition.





ATS INTERIOR

*THE ACCELERATOR, AFTER ALL, ISN'T YOUR ONLY
POINT OF CONTACT.*

The drive to create the finest luxury sport sedan doesn't stop at exceptional dynamics. The ATS reveals its refined side in the precise, handcrafted cut-and-sewn interior. Available leather seating surfaces come in an array of rich colors complete with French stitching, and are finely accented by distinct interior themes featuring exotic woods, aluminum or carbon fiber trim. Every interior detail is driver-focused and brilliantly executed. Complementing the athletic nature of the ATS, bolstered performance seats with cushion-length adjustment are available, helping to keep you firmly planted during spirited driving. On select collections equipped with the 6-speed automatic transmission, you'll find magnesium steering wheel paddle shifters. One tap is all that's required for a crisp upshift or downshift. Dramatically modern and exceptionally refined, nothing has been overlooked inside the ATS cabin.



**AUTHENTIC CARBON
FIBER TRIM**



**MAGNESIUM PADDLE
SHIFTERS**



EXOTIC WOOD TRIM

From its available dramatic Dark Olive Ash (shown here) to the beautiful Sapele and Okapi Stripe designer woods, the stylish ATS interior is emphasized through highly sought-after woods featuring deep, rich graining in alluring colors.

*THE INTUITIVE CONTROL
OF A SMARTPHONE IN YOUR CAR?
JUST A TAP AWAY.*

Employing first-of-its-kind technology, the available CUE¹—Cadillac User Experience—brings the innovative brilliance of your tablet to your entire driving experience. CUE blends revolutionary features with highly intelligent design to create an experience that's as effortless as it is advanced. Its stunning 8" LCD touch screen senses your hand as it approaches. Spread your fingers to zoom in closer on a map. Swipe to breeze through your music. Use the steering wheel controls, or simply speak, and let the Natural Voice Recognition help you effortlessly place a phone call. When an icon is touched, the screen pulses to acknowledge the command, letting you keep your attention focused on the road ahead. CUE also lets you preset up to 60 favorites, including points of interest, addresses and phone numbers, and easily accesses every contact and song on up to ten Bluetooth^{®2}-enabled smartphones. It even streams Pandora Radio.³ Plus, the available 3-D GPS navigation system⁴ has SiriusXM Travel Link⁵ weather maps. With CUE, the customization and content possibilities are not only endless, but also right at your fingertips.

1. Full functionality requires compatible Bluetooth[®] and smartphone. Some devices require USB connectivity.

2. Go to gm.com/bluetooth to find out which Bluetooth phones are compatible with this vehicle. 3. Data plan rates apply. 4. Map coverage available in the United States, U.S. Virgin Islands, Puerto Rico and Canada.

5. Requires active SiriusXM subscription.

ATS

ARCHITECTURE

PERFORMANCE

EXTERIOR

LIGHTING

INTERIOR

CUE

SAFETY TECHNOLOGY

COLLECTIONS

COLOR

WHEELS & SPECS

CONNECTIVITY

Bluetooth² connectivity plus available 3-D GPS navigation, Doppler radar weather, Pandora Radio³ and more.

ADVANCED SAFETY REQUIRES AN ADVANCED WARNING.

The patented available Safety Alert Seat intuitively sends pulses through the seat cushion, left or right or simultaneously, alerting you to a variety of potential hazards.





EXPERIENCE LANE DEPARTURE WARNING

RADAR IN EVERY DIRECTION

Engineers spent countless hours developing the ATS's radar, camera and sensor technologies in real-world tests to provide you with a full complement of safety alerts.

CLICK THE HOTSPOTS TO VIEW ALERTS





*A HIGHLY INNOVATIVE APPROACH TO
PERSONAL PROTECTION.*

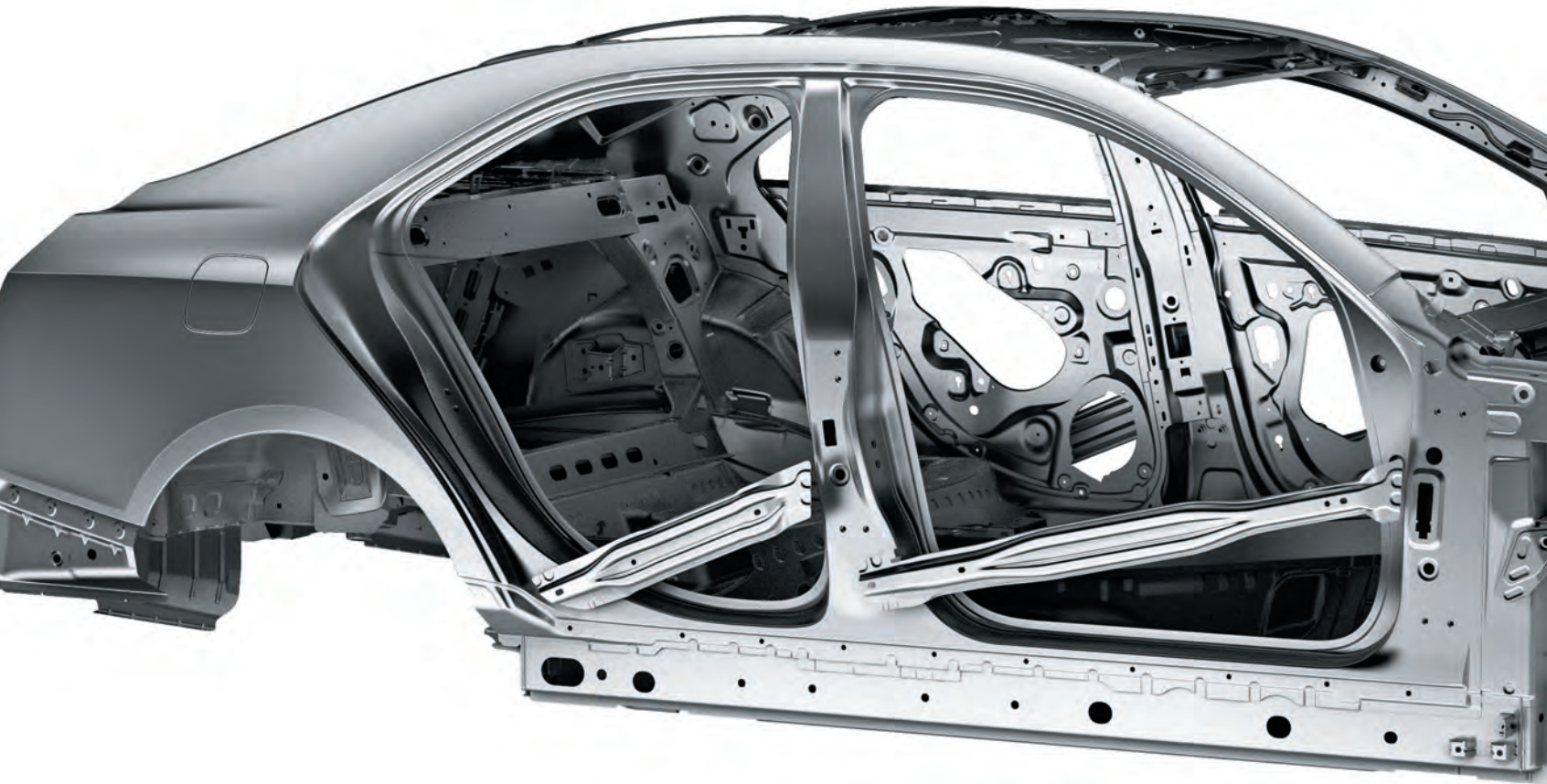

It starts with a protective safety cage constructed with ultra-high-strength steel alloys and other highly advanced materials for exceptional rigidity and strategically placed crumple zones. Then we add preventive safety features like the StabiliTrak Electronic Stability Control and full-function traction control systems. A sophisticated antilock braking system (ABS) with Auto-Dry functionality and Electronic Braking Force Distribution helps balance stopping power between the front and rear brakes. There's also the confidence that comes with eight standard airbags¹ and OnStar^{®2} with Automatic Crash Response. In most crashes, built-in sensors in your vehicle can automatically send an alert to an OnStar Advisor, who is immediately connected in to your car to help.

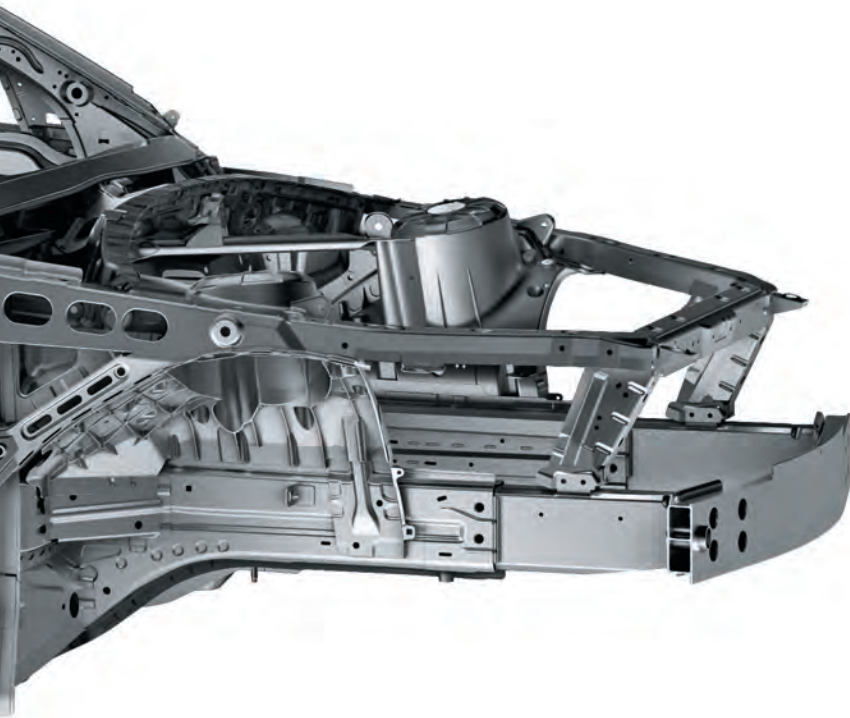

1. Always use safety belts and the correct restraint for your child's age and size. Even in vehicles equipped with the Passenger Sensing System, children are safer when properly secured in a rear seat in the appropriate infant, child or booster seat. Never place a rear-facing infant restraint in the front seat of any vehicle equipped with a passenger air bag. See the Owner's Manual and child safety seat instructions for more safety information. 2. Visit onstar.com for coverage map, details and system limitations. Services vary by model and conditions. OnStar acts as a link to existing emergency service providers.





COLLECTIONS



MAGNETIC RIDE CONTROL

Pioneered by Cadillac and borrowed by Ferrari, the revolutionary Magnetic Ride Control is a class-exclusive feature available on the ATS. It reads and reacts to the road ten times faster than the blink of an eye to keep you firmly in control.

THE PREMIUM COLLECTION:

WHERE CUTTING-EDGE TECHNOLOGY
MEETS THE LEADING EDGE OF PERFORMANCE.



CUE WITH NAVIGATION



RECONFIGURABLE HEAD-UP DISPLAY

The ATS Premium Collection pushes the modern style, agility and advanced technology of the ATS to the highest level. Slide into the premium, leather-laden cabin and enjoy the intuitive brilliance of CUE¹ with 3-D GPS navigation,² Doppler radar weather,³ Pandora Radio⁴ and Bluetooth[®] with streaming audio connectivity.¹ Hit the back roads and encounter the exhilarating driving experience of the ATS, enhanced on the Premium Collection through the revolutionary Magnetic Ride Control,⁵ limited-slip rear differential,⁵ and high-performance summer tires⁵ wrapped over beautiful 18" wheels. To help keep your eyes on the road, there is a full-color reconfigurable Head-Up Display that projects customizable key driving, entertainment and safety information at eye level. It is the ultimate blend of luxury, technology and sport, both inside and out.

1. Full functionality requires compatible Bluetooth and smartphone. Some devices require USB connectivity. 2. Map coverage available in the United States, U.S. Virgin Islands, Puerto Rico and Canada. 3. Requires active SiriusXM subscription. 4. Data plan rates apply. 5. Rear-Wheel Drive models only.



PERFORMANCE SEATS

Providing secure, confidence-inspiring support for both the driver and front-seat passenger, the bolstered Performance Seats are exceptionally comfortable when pushing the performance envelope or pushing through a long drive.

THE PERFORMANCE COLLECTION:

THE LINK BETWEEN MAN AND MACHINE
JUST GOT STRONGER.



RACING-INSPIRED ALUMINUM PEDALS

**DIRECTIONAL HID HEADLAMPS WITH
SIGNATURE LED LIGHTING**

Perfectly suited to its athletic essence, the Performance Collection was developed to bond driver with machine. Bolstered performance front seats are not only exceptionally comfortable, but ensure a firm, planted feel during intense cornering. Aluminum pedals add a racing-inspired touch, and the steering wheel features magnesium paddle shifters for a smooth, crisp gear change on automatic transmission-equipped models. High-Intensity Discharge (HID) headlamps with Adaptive Forward Lighting swivel to cast light into your direction of travel. Drive with the added confidence of innovative safety technologies like Forward Collision Alert and the Safety Alert Seat that help notify you of potential hazards. Top it all off with CUE¹ and a Bose[®] Cabin Surround[®] sound system, and the ATS Performance Collection is both exhilarating and refined.

1. Before making a lane change, always check the SBZA display, check the side and inside rear mirrors, look over your shoulder for vehicles and hazards, and start the turn signal. 2. Full functionality requires compatible Bluetooth[®] and smartphone. Some devices require USB connectivity.



CADILLAC USER EXPERIENCE

CUE¹ is as intuitive as it is advanced. Spread your fingers to zoom in closer on a map. Swipe to breeze through your music. Simply speak and let the Natural Voice Recognition help you effortlessly place a phone call or change your music.

THE LUXURY COLLECTION:

WANTS THAT QUICKLY BECOME NEEDS.



POWER SUNROOF



PREMIUM LEATHER SEATING SURFACES WITH FRENCH STITCHING

The ATS is a remarkable fusion of refined details wrapped in a responsive package further enhanced by the Luxury Collection. Inside, you're greeted with upscale features like eight-way power adjustable front seats plus two-way power lumbar, a memory package, supple leather seating surfaces with French-stitched seams, and the cutting-edge technology of CUE.¹ The bold front-end design of the ATS is highlighted with a unique Midnight Chrome-accented grille. Parking is a breeze with the convenience of the rear-vision camera, in addition to Front and Rear Park Assist. Discover the luxury of Passive Entry with adaptive vehicle remote start, the clarity of SiriusXM Satellite Radio^{2,3} and HD radio to add the finishing touches on an exceptionally sophisticated package.

1. Full functionality requires compatible Bluetooth® and smartphone. Some devices require USB connectivity. 2. Standard for three months. 3. If you subscribe after your trial period, subscriptions are continuous until you call SiriusXM to cancel. See SiriusXM Customer Agreement for complete terms at www.siriusxm.com. Other fees and taxes will apply. All fees and programming subject to change. For more information about NavTraffic, visit siriusxm.com/navtraffic. For more information about Travel Link, visit siriusxm.com/travellink. XM satellite service is available only to those in the 48 contiguous USA and DC. Sirius, XM and all related marks and logos are trademarks of Sirius XM Radio Inc.



*RADIANT SILVER
METALLIC*



*GLACIER BLUE
METALLIC*



*WHITE DIAMOND
TRICOAT¹*

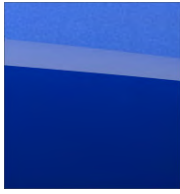

*OPULENT BLUE
METALLIC*



*SILVER COAST
METALLIC*

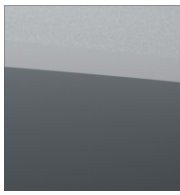

*THUNDER GRAY
CHROMAFLAIR^{®1}*

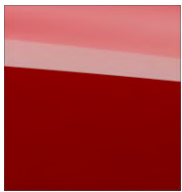

*CRYSTAL RED
TINTCOAT¹*

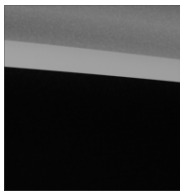

BLACK RAVEN

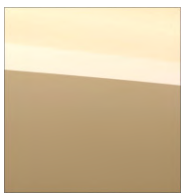

*SUMMER GOLD
METALLIC*

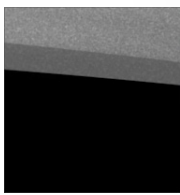

*BLACK DIAMOND
TRICOAT¹*



PAINT

TINTCOAT

A premium
the added
the finish

1. Available at extra cost.

CUSTOMIZE YOUR *ATS EXTERIOR*

[BUILD YOUR OWN >>](#)

[LOCATE A DEALER >>](#)



PAINT FINISHES

DIAMOND COAT

A premium 2-layer paint application with the addition of a tinted clearcoat, lending your finish an extra depth and brightness.

TRICOAT

A meticulous 3-layer process that results in a dramatic hue-shifting color.

CHROMAFLAIR®

An advanced, light interference paint technology with prismatic metallic pigments to create intense, deeply lustrous color.

ATS

ARCHITECTURE

PERFORMANCE

EXTERIOR

LIGHTING

INTERIOR

CUE

SAFETY TECHNOLOGY

COLLECTIONS

COLOR

WHEELS & SPECS

Jet Black¹ / Jet Black Accents / Oil-Rubbed Bronze Appearance Trim



Caramel¹ / Jet Black Accents / Oil-Rubbed Bronze Appearance Trim



Morello Red² / Jet Black Accents / Carbon Fiber Trim



Light Platinum² / Brownstone Okapi Stripe Wood Trim



1. Leatherette seating. 2. Leather seating surfaces.



THE STANDARD OF THE WORLD AT YOUR FINGERTIPS

We set out to create our own uniquely American breed of extraordinary. Each built with tenacity, a refusal to leave well enough alone. From dramatic designs to world-class performance, we're setting the standard. To stay current, we invite you to sign up for our monthly eNewsletter. You'll receive invitations to exclusive events, the latest product news and information and launch updates.

SIGN UP »

ATS INTERIOR CHOICES

[BUILD YOUR OWN >>](#)

[LOCATE A DEALER >>](#)

Jet Black² / Jet Black Accents /
Brushed Aluminum Trim



Light Platinum² / Jet Black Accents /
Sapele Wood Trim



ne Accents /

Caramel² / Jet Black Accents /
Dark Olive Ash Wood Trim





59.5"
71.1"



109.3"
182.8"

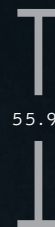

55.9"



60.9"

**18" FORGED ALUMINUM WITH
MACHINED FINISH**

Standard on ATS Premium Collection,
available on ATS Performance Collection

Performance and Premium Collection AWD
size: 18"×8" front and rear and includes
P225/40R18 all-season run-flat tires

Premium Collection RWD, Size: 18"×8"
front and 18"×9" rear and includes
performance summer-only¹ run-flat tires;
P225/40R18 front and P255/35R18 rear.



ATS WHEEL CHOICES

[BUILD YOUR OWN >>](#)

[LOCATE A DEALER >>](#)



17" ALUMINUM WITH PREMIUM PAINTED FINISH

Standard on ATS, includes P225/45R17 all-season tires, Size: 17"x8" front and rear



17" ALUMINUM WITH PREMIUM PAINTED FINISH

Standard with ATS Performance Collection; includes P225/45R17 all-season run-flat tires Size: 17"x8" front and rear



17" ALUMINUM WITH POLISHED FINISH

Standard with ATS Luxury Collection and available on ATS Standard model; includes P225/45R17 all-season run-flat tires, Size: 17"x8" front and rear



18" FORGED ALUMINUM WITH POLISHED FINISH

Available on ATS Luxury and Premium Collections

Luxury Collection AWD size: 18"x8" front and rear and includes P225/40R18 all-season run-flat tires

Premium Collection RWD, Size: 18"x8" front and 18"x9" rear and includes performance summer-only¹ run-flat tires; P225/40R18 front and P255/35R18 rear

1. Summer-only tires tend to wear faster and are more susceptible to damage from road hazards or curb impact than standard profile tires. This type of damage is not covered by the GM New Vehicle Limited Warranty. You may want to get different tires if you expect to drive in winter conditions. See your dealer for proper tire selection.

ABOUT THIS DIGITAL CATALOG

We have tried to make the information presented comprehensive and factual. We reserve the right, however, to make changes at any time, without notice, in prices, colors, materials, equipment, specifications, models and availability. Specifications, dimensions, measurements, ratings and other numbers presented here and in printed materials provided at the dealership or affixed to vehicles are approximates, based upon design and engineering drawings and prototypes and laboratory tests. Your vehicle may differ due to variations in manufacture and equipment. Since some information may have been recently updated, please check with your Cadillac dealer for complete details. Cadillac reserves the right to lengthen or shorten the model year for any product for any reason, or to start and end model years at different times. Note: Some photographs show vehicles with optional equipment.

ONSTAR OnStar services require vehicle electrical system (including battery), wireless service and GPS satellite signals to be available and operating for features to function properly. OnStar acts as a link to existing emergency service providers. Subscription Service Agreement required. Call 1-888-4ONSTAR (466-7827) or visit onstar.com for OnStar's Terms and Conditions, Privacy Policy and details and system limitations.

ENGINES Cadillac products are equipped with engines produced by GM Powertrain or suppliers to GM worldwide. The engines in Cadillac products may also be used in other GM makes or models.

TIRE SEALANT AND COMPRESSOR KIT

After using the inflator kit, it is recommended to take the tire to an authorized dealer for inspection and repair as soon as possible but at least within 100 miles of driving. The tire sealant cannot seal and inflate sidewall damage, punctures larger than 1/4 inch, or a tire that has unseated from the wheel. The sealant can only be used on one tire one time before its expiration date.

ASSEMBLY Cadillac vehicles and their components are assembled or produced by different operating units of General Motors, its subsidiaries or suppliers to GM worldwide. We sometimes find it necessary to produce Cadillac vehicles with different or differently sourced components than originally scheduled. Since some options may be unavailable when your vehicle is assembled, we suggest that you verify that your vehicle includes the equipment you ordered or, if there are changes, that they are acceptable to you.

UPDATED SERVICE INFORMATION

Cadillac dealers receive useful service bulletins about Cadillac products. You may purchase them from Helm Incorporated by calling 1-800-551-4123 or by visiting www.helminc.com.

NEW-VEHICLE LIMITED WARRANTY

World-class coverage comes standard on every 2013 Cadillac. This warranty is for Cadillac vehicles registered in the U.S.A. See your Cadillac dealer for terms and conditions.

COVERED FOR 6 YEARS/70,000 MILES (WHICHEVER COMES FIRST)

Powertrain Limited Warranty with no deductible, Roadside Assistance Program,¹ Courtesy Transportation Program.¹

COVERED FOR 4 YEARS/50,000 MILES (WHICHEVER COMES FIRST)

Bumper-to-Bumper coverage; Tires – Defects in material and workmanship; Repairs made to correct any vehicle defect; Corrosion on body sheet metal panels.

RUST THROUGH PROTECTION Cadillac vehicles are designed and built to resist corrosion and rust-through corrosion. Any body sheet metal that rusts through (in the form of an actual hole in the sheet

metal) is covered for six years unlimited mileage. Cosmetic or surface corrosion, resulting from stone chips or scratches in the paint, for example, is not included in the Rust Through coverage. Application of additional rust-inhibiting materials is not required under the Rust Through coverage and none is recommended. See your Cadillac dealer for terms of this limited warranty.

FLEET ORDERS Some standard content may be deleted with fleet orders. See dealer for details.

1. Roadside Assistance Program and Courtesy Transportation Program are not a part of the New Vehicle Limited Warranty. A separate booklet entitled "Warranty and Owner Assistance Information" furnished with each new vehicle provides detailed warranty coverage information.

GM, the GM emblem, Cadillac, the Cadillac badge, OnStar, the OnStar emblem and the slogans, emblems, vehicle model names, vehicle body designs and other marks appearing in this catalog are the trademarks and/or service marks of General Motors, its subsidiaries, affiliates or licensors. iPod is a registered trademark of Apple, Inc.

©2012 General Motors. All rights reserved.