

there's more  
driving  
enjoyment  
with

 Pontiac  
Stylized  
Accessories



order your accessories  
by the group  
—and **save!**

For your convenience—and considerable saving—Pontiac accessories are available by the group for installation at the factory. They are added to your car according to your order as it is being built. Your '57 Pontiac is delivered tailored to your exact needs and specifications—and at a sizable saving in time and money. Look over the list of accessory groups on the next page and the information on each in the following pages. Your dealer will gladly help you pick the group or groups most suitable to your needs and order your car delivered accordingly.

You can, of course, order your accessories individually. Some of these, too, can be installed at the factory—at a sizable saving. Others are available for dealer installation only. There is an illustrated list of accessories available through individual order in the last section of this pamphlet.



### basic group

Underseat Heater and Defroster  
De Luxe Radio and Manual Antenna  
Latex Foam Cushion—Front Only  
Oil-Bath Air Cleaner  
Full-Flow Oil Filter

### de luxe basic group

Underseat Heater and Defroster  
Hi-Fi Dual Rear Seat Speakers (Except Convertible and Safaris)  
De Luxe Electramatic Wonder Bar Radio and Electric Antenna  
Custom Lounge Latex Foam Cushion—Front Only  
Oil-Bath Air Cleaner  
Full-Flow Oil Filter

### lamp group

Back-Up Lamps  
Glove Compartment Lamp  
Luggage and Utility Lamp (Underhood and Utility Lamp on Safaris)  
Ash Tray Lamps (Includes RH Ash Tray on Chieftain Models)  
Parking Brake Warning Lamp

### mirror group

Outside Rear-View Mirror  
Inside Non-Glare Tilt Mirror  
Visor Vanity Mirror



## basic group

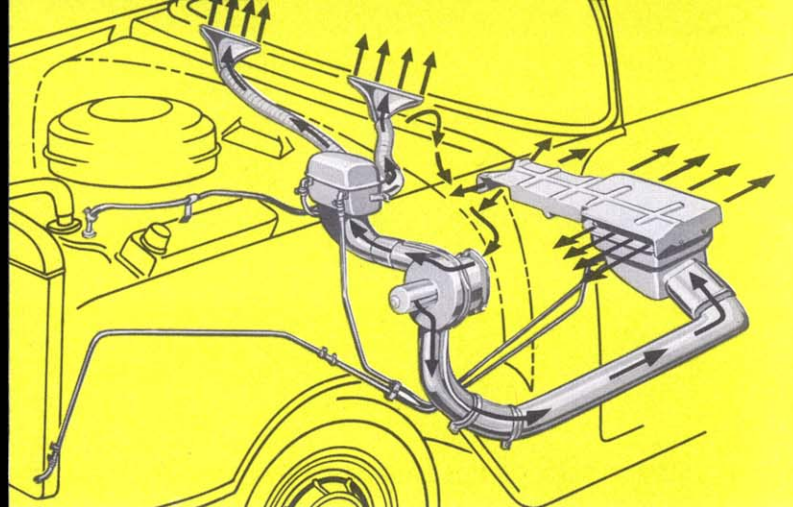

### UNDERSEAT HEATER AND DEFROSTER

New longer heater core and more powerful blower insure better heat and heat distribution. Separate defroster unit keeps windshield free of "fogging up". Complete temperature range controlled by two horizontal levers on instrument panel. Blower switch has "off"- "lo"- "hi"- positions to permit selection of ideal blower speed.



### DE LUXE RADIO AND MANUAL ANTENNA

Low-voltage transistorized receiver needs less voltage for strong, clear reception. Five push buttons for pre-selected stations . . . tone control, switch and manual selector control. Speaker located on fire wall for better sound distribution. Antenna reaches to 57 inches to receive distant stations clearly, sharply.



### LATEX FOAM CUSHIONS

(Front only) . . . deep-cushioned front seat comfort—give firm, even support. Tiny air holes in 1¼-inch-thick latex foam cushions reduce road shock, make your ride more enjoyable, less fatiguing. Air holes give added comfort of "air cushioning." Allow cushions to conform to each body contour.



### OIL-BATH AIR CLEANER AND FULL-FLOW OIL FILTER

Air cleaner screens all incoming air through an oil pool before it enters engine. Removes all dust and other harmful particles. Oil filter removes all foreign matter from every drop of oil before it circulates through engine. Both insure better performance . . . longer engine life.



## de luxe basic group



### DE LUXE ELECTRAMATIC RADIO AND ELECTRIC ANTENNA

5 push buttons and the Wonder Bar automatic "signal-seeking" feature . . . find nearest and strongest station at a finger's touch . . . tune it in with amazing clarity and strength. The new radio speaker is located below the instrument panel for better sound distribution. Electric antenna rises to approximately 30 inches automatically when radio is turned "on" . . . lowers when turned to "off". A manual override switch allows antenna height of 57 inches for more and stronger station reception and positive operation of the tuning mechanism. New low voltage receiver means more power, less voltage, longer life.

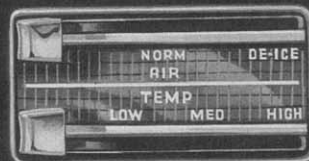
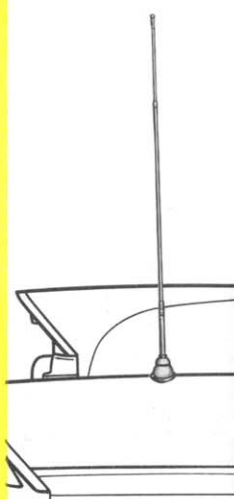

### UNDERSEAT HEATER AND DEFROSTER

The new underseat heater core and the more powerful blower motor insure more heat and better heat distribution. The separate defroster unit keeps the windshield free from frost or "fogging up". The blower switch has a three-stage operation—"off"—"lo"—"hi"—for ideal blower speed selection.

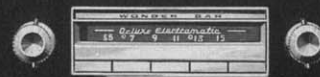
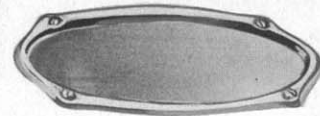

### HI-FI DUAL REAR SEAT SPEAKERS

(Except Convertible and Safaris) . . . two speakers mounted on rear package shelf combined with front seat speaker bring remarkable depth . . . tone . . . quality to radio sound. Rear speaker control knob located below radio on the instrument panel has four positions to bring maximum listening pleasure to both front and rear seat passengers.



### OIL-BATH AIR CLEANER AND FULL-FLOW OIL FILTER

To safeguard finely machined parts of engine . . . save costly repairs . . . prolong engine life. Incoming air in air cleaner passes over pool of oil which picks up harmful dust and dirt particles, preventing their entering engine. Oil filter screens all foreign matter from oil before it circulates through the engine. Special design permits oil to bypass filter if it should become clogged.



### CUSTOM LOUNGE LATEX FOAM CUSHIONS

(Front only) . . . the ultimate in soft, firm, deep-cushioned riding comfort. Specially constructed 2¼-inch foam rubber with tiny air holes allow seat to "breathe" . . . give added comfort by forming to fit every contour of the body. Relieves tension and fatigue of long trips. Makes every mile more enjoyable.



## lamp group

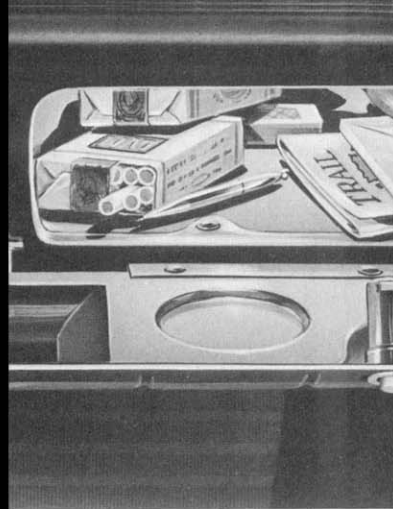

### GLOVE COMPARTMENT LAMP

Automatically lights when compartment is opened. Ends fumbling in the dark . . . searching for needed items. All items are quickly, easily available at the touch of a button.

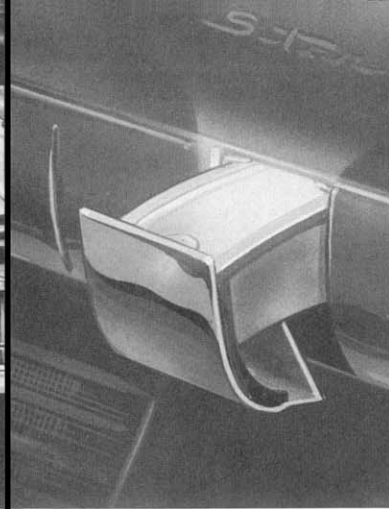

### ASH TRAY LAMP

Gives off suffused glow when lights are turned on . . . visible when ash tray is pulled from its recess. Dual lamps available for car with dual ash trays. Reach ash trays with ease . . . avoid danger of fire.

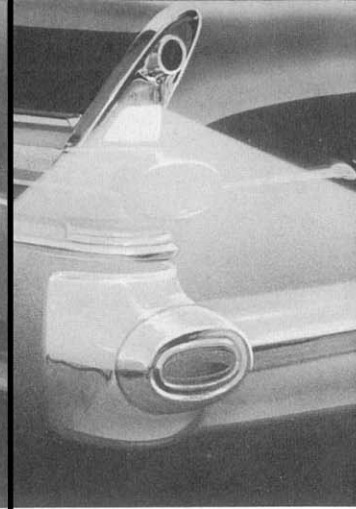

### DUAL BACK-UP LAMPS

Light up automatically as you shift into reverse. Illuminate entire area in back of car. Make backing up at night much easier, safer . . . warn pedestrians and other cars of your intentions.



### LUGGAGE COMPARTMENT LAMP

Lights up automatically when lid is lifted . . . floods compartment with light. Lamp lifts easily from bracket and with 17-foot self-storing extension cord may be used anywhere around the car.

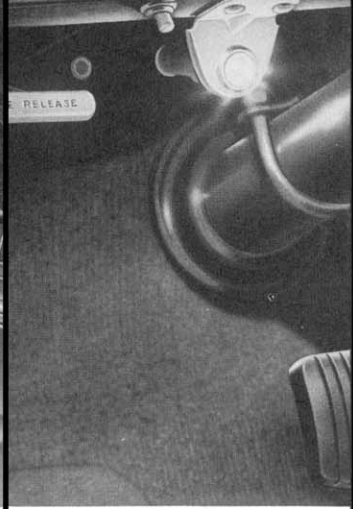

### NEW PARKING BRAKE WARNING LAMP

Mounted on lower left side of instrument panel—flashes bright red when ignition is on and brake is set. Continues to flash until brake is released. Helps prevent possible brake damage.

## mirror group

### INSIDE NON-GLARE TILT MIRROR

All-new design with increased mirror area and adjustable height. Special finger tabs marked "DAY" and "NIGHT" permit easy adjustment to non-glare nighttime or daytime driving positions.

### OUTSIDE REAR-VIEW MIRROR

Restyled to fit with Pontiac's new Star Flight body design. Special hood around mirror area and "Cromir" reflecting surface prevent glare, blurring, produce clear, sharp reflection. Designed for mounting on fenders or doors.

### VISOR VANITY MIRROR

Ideal for milady's use in repairing make-up . . . applying lipstick. Clips neatly on the underside of right-hand visor. Pull the visor down and it's ready for use. Handy for men too for a needed electric shave on a business trip . . . for combing hair. Swings out of view after use.

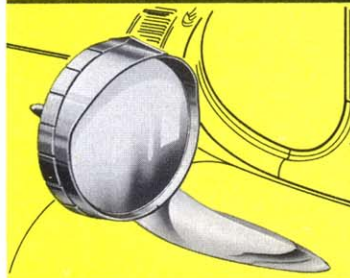

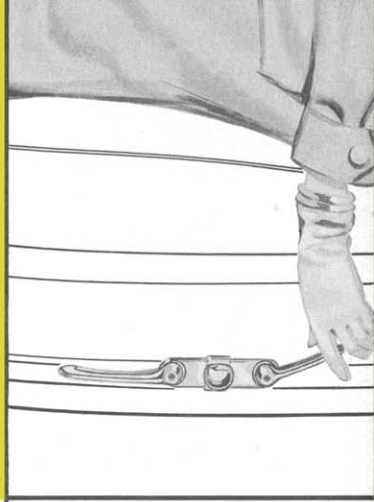
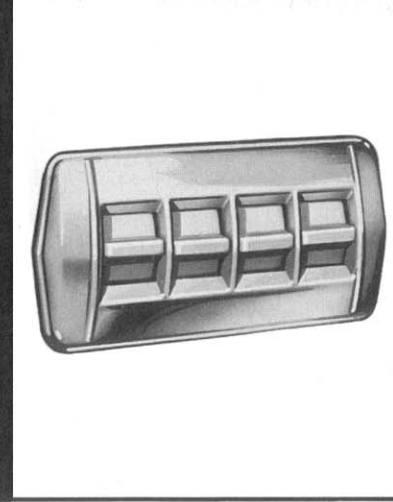
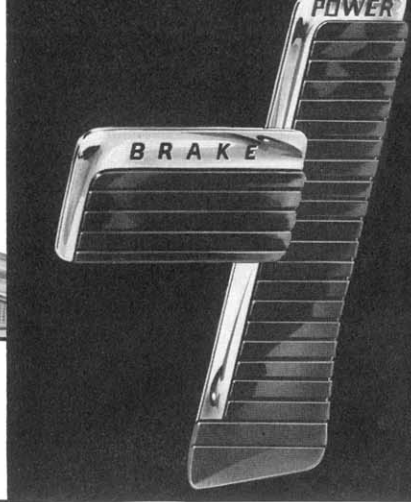

## individual accessories

### POWER STEERING

An important safety addition—in case of blowouts or wheels contacting soft shoulders, heavy sand or snow . . . takes the push and pull out of parking and tight turns . . . eliminates up to 87% of the effort needed in difficult steering situations, but you still retain the important "road feel" of the car under all driving conditions.

### POWER BRAKES

Assuring smooth, even, almost effortless stops at a touch . . . still provide "stopping feel" at all times, eliminating "grabbing" action. Included is new power brake pedal with over 10½ sq. inches of area. Reduced pedal travel and application effort effect faster, easier stopping. Matching accelerator pedal with word "Power" inscribed.

### POWER WINDOW LIFTS

At a finger's touch all vertical-moving windows can be raised or lowered from control panel near driver's seat. Individual controls for passengers located in panel below each window. If traveling alone you can regulate exact window ventilation desired throughout the car.

### ELECTRIC WINDSHIELD WIPERS

Increase visibility by 20% with longer arm, blade and wider sweep. Can be set to operate at fast or medium speed. When set . . . wiper speed is always constant. Eliminates danger of reduced visibility through slower wiper action . . . during sudden acceleration, or going up hills.

### 8-WAY POWER COMFORT CONTROL SEAT

In a matter of seconds, customized seating comfort tailored to your exact position preference. Eight-way action includes movement forward and backward—tilting both front or back of the seat up or down—and raising or lowering entire seat vertically. Controls are located on the left end of the front seat.

### 6-WAY MANUAL COMFORT CONTROL SEAT

Offers 360 different positions with its forward-backward movement—lilting of the front or back of the seat—and raising or lowering of seat vertically. Similar action to power seat, but accomplished manually. You'll find changing seat positions on long trips relieves fatigue—makes driving more relaxed—enjoyable.

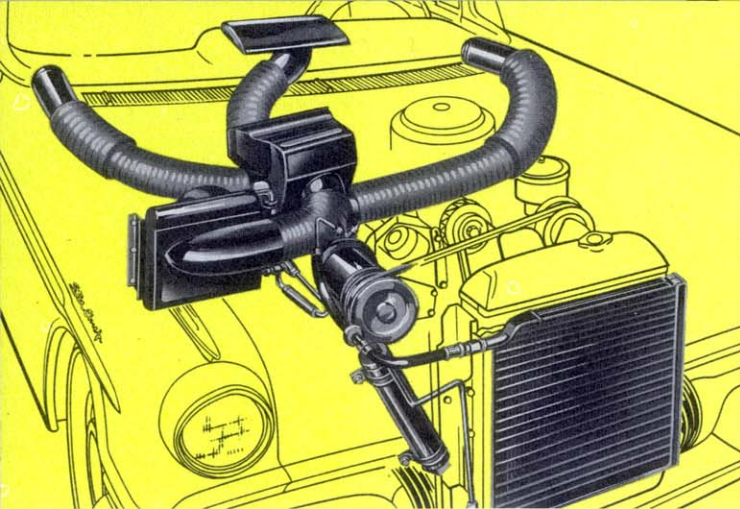

#### PONTIAC YEAR-ROUND AIR CONDITIONING

With even greater heat dissipating capacity for '57 and new, convenient control location near top of instrument panel. Supplies cool, clean, dry air month in, month out. You'll use it as much in spring and fall as summer to keep air cool, odorless, dehumidified—offers year-round driving comfort. Keeps you comfortably relaxed on the longest, hottest trips. You arrive refreshed, free of heat fatigue and tension.



#### "AUTRONIC-EYE" HEADLAMP BEAM CONTROL

Control headlights at night automatically. The "Autronic-Eye" dims your lights as cars approach—returns them to bright after car passes. Floor switch lets you override automatic action if desired.

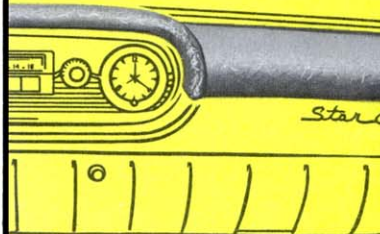

#### INSTRUMENT PANEL CUSHION

Shock-absorbing instrument panel pad finished in a durable fabric that eliminates light reflections and padded with resilient long-lasting plastic foam. Available in a wide choice of colors to harmonize with your interior color selection.

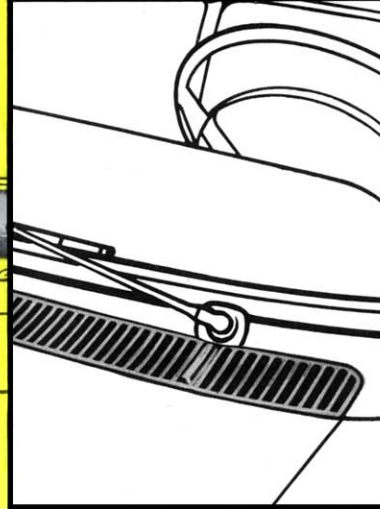

#### COWL VENT CHROME TRIM

For all Super Chief and Chieftain models. Adds a smart touch of distinction and de luxe style to your hood top. Exactly the same trim included on all Star Chief models. Give your car that "Star Chief" look.

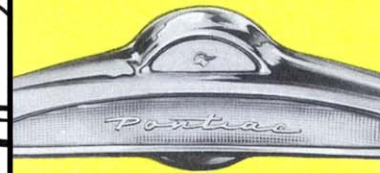

#### DE LUXE STEERING WHEEL

Safety scooped in design, the de luxe 17½" two-spoke reinforced-plastic wheel and chrome horn ring are available for installation on all Chieftain models. Center design in gold checkered plastic.



#### ELECTRIC CLOCK

Features a sweep second hand and a built-in automatic regulator. Fast or slow adjustment controlled by simply resetting the hands of the clock. Illuminated dial for easy reading. A convenience you'll use many times a day.

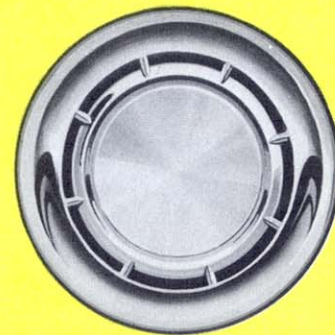

#### CHROME WHEEL DISCS

Add distinction and over-all smart appearance to your wheels. These chrome-plated stainless-steel discs require only washing to retain their sparkling finish. Glamorous, durable additions to your car's appearance.



#### WINDSHIELD WASHERS

Newly designed with control button on instrument panel. Through the action of a coupler attached to the wiper motor, washer action is co-ordinated with windshield wiper action. Wipers continue to operate 8-10 cycles after predetermined amount of water has been pumped from washer jar.



#### REAR WINDOW DEFROSTER

In cold weather you need clear, safe vision to the rear, too. A flick of the switch and this high-volume blower—conveniently mounted on the rear package shelf—recirculates the warmed air inside the car, melts frost in a few minutes and keeps window free of fogging up!



#### E-Z-EYE GLASS

Tinted in a deepening shade from bottom to top. Filters sun's glare and heat. Relieves eyestrain. Helps keep car cooler. Reduces glare of oncoming headlights at night. Window and back glass have uniform tint. Available windshield only or in all glass. Factory installation only.

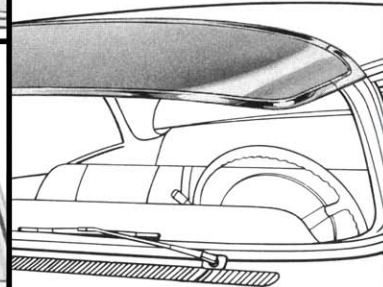

#### SUN VISOR AND VIEWER

Visor forms an "awning" over top of front windshield. You're always in the shade. Reduces sun glare and eyestrain. Keeps car cooler. Unique traffic light viewer mounts on instrument panel. You can see overhead signals at a glance. Both sold as a package.

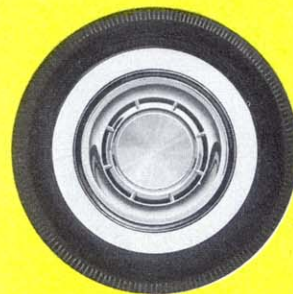

#### WHITE SIDEWALL TIRES

For extra glamour and distinction on any Pontiac model. Give it that neat, well-trimmed appearance. An added touch of style and glamor that highlights your Pontiac's big car beauty.

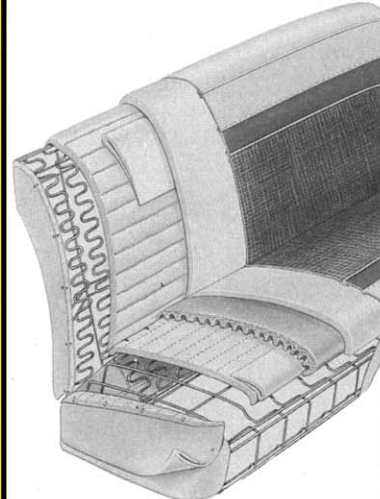

#### LATEX FOAM REAR CUSHIONS

Let all passengers enjoy the cloud-soft, firm, even ride of latex foam. Tiny air holes in foam reduce road shock, give firm, even support because cushions conform perfectly to body contours. Air holes allow cushions to "breathe"—give added comfort of "air-cushioning."

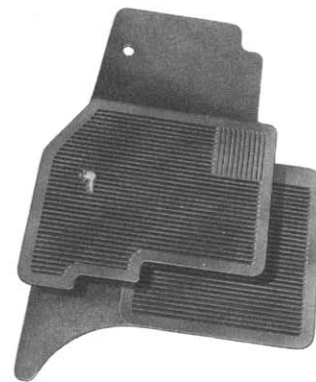

#### FLOOR MATS

Prevent unsightly mud, rain and snow stains on your floors. These easily removed mats help keep your Pontiac "new car" clean. Made to fit Pontiac front and rear floor interiors in a wide variety of colors to harmonize with your interior.

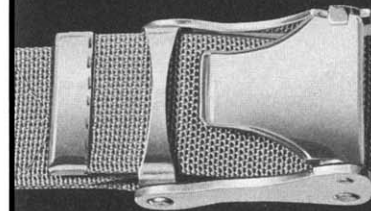

#### SEAT BELTS

Pontiac seat belts feature a heavy-cam-action aluminum buckle and heavy webbing, both designed to meet established specifications of NACA and SAE. Available in two colors in individual packages for each passenger. Tested and proved under the most rigorous conditions.



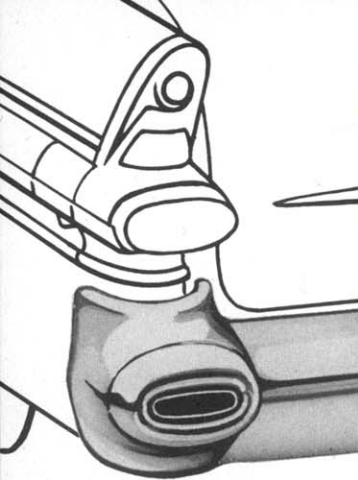

#### DUAL EXHAUST

Gives your car added beauty plus improved engine performance. New design with tailpipes going through the bumper—(except on Safaris). Safari tailpipes pass under rear bumper and fan out to the sides. (Not available on Four-Door Chieftain Safari.)

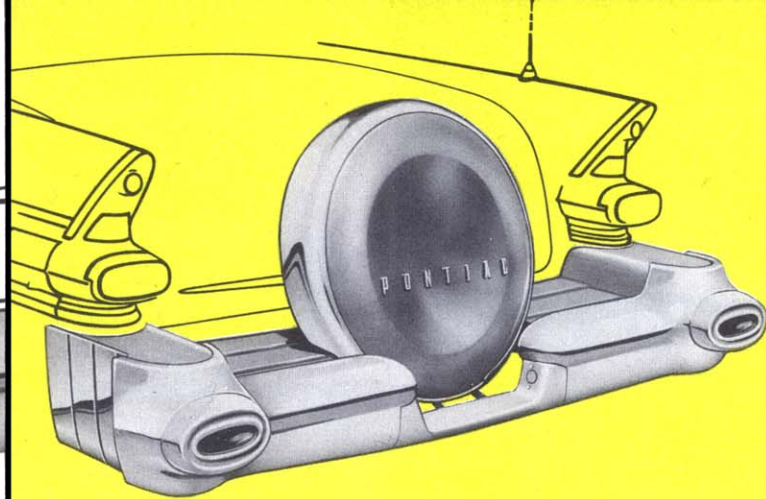

#### CONTINENTAL TIRE KIT

Gives your Pontiac that longer customized look. Release handle moves spare tire aside and trunk area is completely accessible. Swings back to the right and locks in place. Available with solid or open plate and stainless or painted rim. A distinctive addition that individualizes your car.



#### WIRE WHEEL DISCS

Give your car that "sports car" look with these attractive discs. Made of durable light aluminum. Attach to the wheel by spring clips for easy cleaning of the wheel. Aluminum construction requires only damp cloth for discs to maintain their gleaming finish.

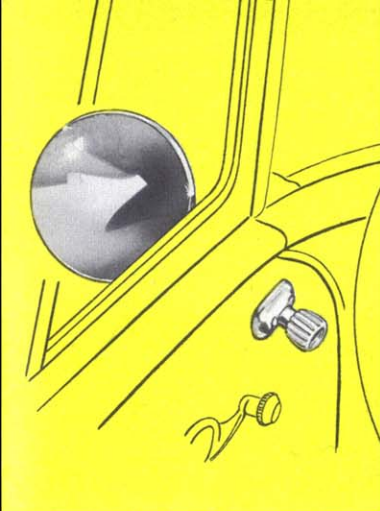

#### REMOTE-CONTROL MIRROR

Does away with reaching out through window or inconvenient stopping to adjust. Mirror's position controlled from inside the car. Beautifully chrome plated with "Cromir" reflecting surface for clear, sharp reflection . . . no blurring or "ghosting".

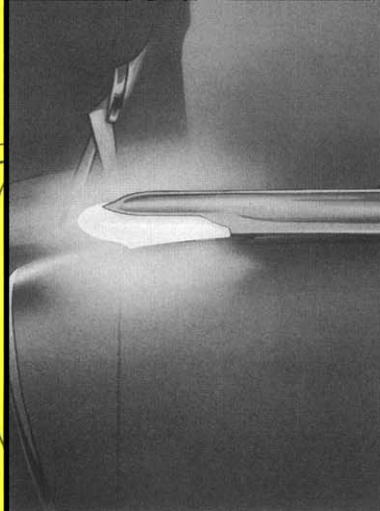

#### ILLUMINATED FENDER ORNAMENTS

Fashioned after standard front fender ornaments, but with broader wings. Nose piece of clear plastic glows softly when lights are turned on. Adds the touch of glamour and distinction to your car.

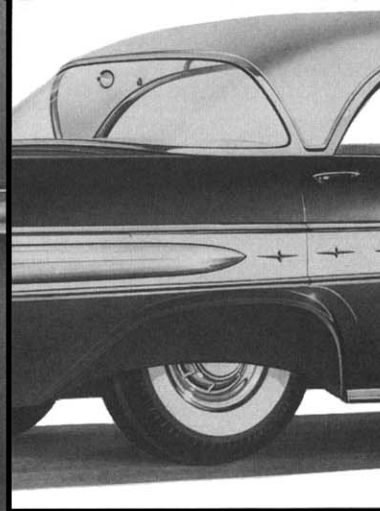

#### FENDER SHIELDS

A perfect styling touch by continuing the long flowing lines of Pontiac's Star Flight body design—accentuate your car's long low look. Minimize wheel splash . . . keep car cleaner. Reduce the possibility of damage to fender finishes from road dust and tars.

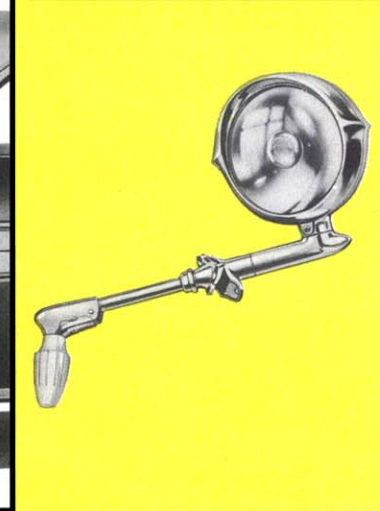

#### PONTIAC SPOTLIGHT

An invaluable convenience for checking road signs, house numbers, etc. Newly designed interior control handle in keeping with all-new interior design. Attached "Cromir" rear-view mirror also controlled from inside the car by turning spotlight handle.



#### COMPASS

Illuminated to give you the direction you're driving night or day. Mounted on the top center of the instrument panel for easy viewing by all passengers. Two easily accessible set screws make possible a quick and accurate "setting."

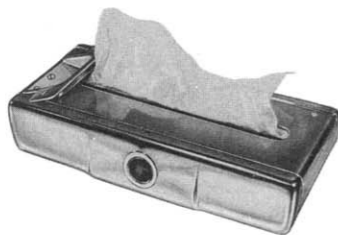

#### TISSUE DISPENSER

To hold the tissues with a hundred and one different uses. Mounts handy under the instrument panel . . . swings out for use . . . back out of the way when not in use. Finished in gleaming chrome.



#### KOOL KOOSHION

These flexible lightweight seat pads with special coil-spring construction allow air to circulate between passenger and seat. Ideal for summer driving and use in air-conditioned cars.



#### ELECTRIC SHAVER

However heavy the business or social schedule, you can shave in your car and always be well-groomed. Ideal for traveling representatives. Plugs into lighter receptacle. Operates equally well on either 12 or 110 volts.



#### UNDERCOATING

Protects vital parts of the car exposed to the road surface . . . prevents rust damage, deterioration of underside surfaces . . . deadens the sound of stones and other objects hitting the bottom of the car.

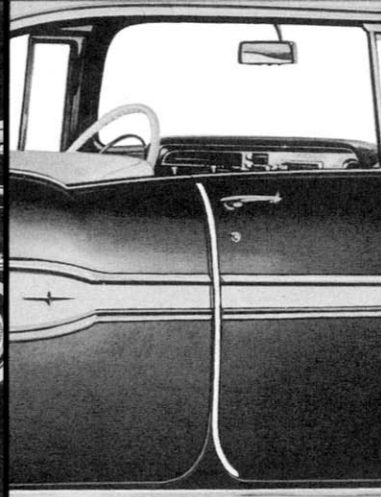

#### DOOR EDGE GUARD

Gleaming, stainless-steel strip, that adds beauty and protection to your new Pontiac exterior. Prevents nicks and scratches on the edge of the door. Can be installed in minutes.



#### COURTESY LAMPS

Convenient aid that lights door sill and curb whenever front door is opened. May be operated manually by switch on instrument panel when door is closed.



#### HAND SPOTLAMP

An all-purpose portable lamp with 12-foot extension cord . . . a spotlight for house numbers, road signs, etc. . . a trouble lamp to illuminate any section of the car. Plugs into lighter receptacle.

LET OUR SALESMEN SHOW YOU HOW  
YOU CAN DOUBLE YOUR DRIVING  
FUN WITH FACTORY-ENGINEERED

**PONTIAC ACCESSORIES!**

and by  
the way—let  
us show you how easy  
Pontiac accessories can  
fit into your car  
budget too—